

CHAPTER 23

WOOD

SECTION 2301 GENERAL

2301.1 Scope. The provisions of this chapter shall govern the materials, design, construction and quality of wood members and their fasteners.

2301.2 General design requirements. The design of structural elements or systems, constructed partially or wholly of wood or wood-based products, shall be in accordance with one of the following methods:

1. Allowable stress design in accordance with Sections 2304, 2305 and 2306.
2. Load and resistance factor design in accordance with Sections 2304, 2305 and 2307.
3. Conventional light-frame construction in accordance with Sections 2304 and 2308.

Exception: Buildings designed in accordance with the provisions of the AF&PA WFCM shall be deemed to meet the requirements of the provisions of Section 2308.

2301.3 Nominal sizes. For the purposes of this chapter, where dimensions of lumber are specified, they shall be deemed to be nominal dimensions unless specifically designated as actual dimensions (see Section 2304.2).

SECTION 2302 DEFINITIONS

2302.1 Definitions. The following words and terms shall, for the purposes of this chapter, have the meanings shown herein.

ACCREDITATION BODY. An approved, third-party organization that is independent of the grading and inspection agencies, and the lumber mills, and that initially accredits and subsequently monitors, on a continuing basis, the competency and performance of a grading or inspection agency related to carrying out specific tasks.

BRACED WALL LINE. A series of braced wall panels in a single story that meets the requirements of Section 2308.3 or 2308.12.4.

BRACED WALL PANEL. A section of wall braced in accordance with Section 2308.9.3 or 2308.12.4.

COLLECTOR. A horizontal diaphragm element parallel and in line with the applied force that collects and transfers diaphragm shear forces to the vertical elements of the lateral-force-resisting system and/or distributes forces within the diaphragm.

CONVENTIONAL LIGHT-FRAME WOOD CONSTRUCTION. A type of construction whose primary structural elements are formed by a system of repetitive wood-framing members. See Section 2308 for conventional light-frame wood construction provisions.

CRIPPLE WALL. A framed stud wall extending from the top of the foundation to the underside of floor framing for the lowest occupied floor level.

DIAPHRAGM, UNBLOCKED. A diaphragm that has edge nailing at supporting members only. Blocking between supporting structural members at panel edges is not included. Diaphragm panels are field nailed to supporting members.

DRAG STRUT. See “Collector.”

FIBERBOARD. A fibrous, homogeneous panel made from lignocellulosic fibers (usually wood or cane) and having a density of less than 31 pounds per cubic foot (pcf) (497 kg/m³) but more than 10 pcf (160 kg/m³).

GLUED BUILT-UP MEMBER. A structural element, the section of which is composed of built-up lumber, wood structural panels or wood structural panels in combination with lumber, all parts bonded together with structural adhesives.

GRADE (LUMBER). The classification of lumber in regard to strength and utility in accordance with American Softwood Lumber Standard DOC PS 20 and the grading rules of an approved lumber rules-writing agency.

HARDBOARD. A fibrous-felted, homogeneous panel made from lignocellulosic fibers consolidated under heat and pressure in a hot press to a density not less than 31 pcf (497 kg/m³).

NAILING, BOUNDARY. A special nailing pattern required by design at the boundaries of diaphragms.

NAILING, EDGE. A special nailing pattern required by design at the edges of each panel within the assembly of a diaphragm or shear wall.

NAILING, FIELD. Nailing required between the sheathing panels and framing members at locations other than boundary nailing and edge nailing.

NATURALLY DURABLE WOOD. The heartwood of the following species with the exception that an occasional piece with corner sapwood is permitted if 90 percent or more of the width of each side on which it occurs is heartwood.

Decay resistant. Redwood, cedar, black locust and black walnut.

Termite resistant. Redwood and Eastern red cedar.

NOMINAL SIZE (LUMBER). The commercial size designation of width and depth, in standard sawn lumber and glued-laminated lumber grades; somewhat larger than the standard net size of dressed lumber, in accordance with DOC PS 20 for sawn lumber and with the AF&PA NDS for glued-laminated lumber.

PARTICLEBOARD. A generic term for a panel primarily composed of cellulosic materials (usually wood), generally in the form of discrete pieces or particles, as distinguished from fibers. The cellulosic material is combined with synthetic resin or other suitable bonding system by a process in which the

interparticle bond is created by the bonding system under heat and pressure.

PREFABRICATED WOOD I-JOIST. Structural member manufactured using sawn or structural composite lumber flanges and wood structural panel webs bonded together with exterior exposure adhesives, which forms an “I” cross-sectional shape.

PRESERVATIVE-TREATED WOOD. Wood (including plywood) pressure treated with preservatives in accordance with Section 2303.1.8.

SHEAR WALL. A wall designed to resist lateral forces parallel to the plane of a wall.

Shear wall, perforated. A wood structural panel sheathed wall with openings, that has not been specifically designed and detailed for force transfer around openings.

Shear wall segment, perforated. A section of shear wall with full-height sheathing that meets the height-to-width ratio limits of Section 2305.3.4.

STRUCTURAL COMPOSITE LUMBER. Structural member manufactured using wood elements bonded together with exterior adhesives. Examples of structural composite lumber are:

Laminated veneer lumber (LVL). A composite of wood veneer sheet elements with wood fibers primarily oriented along the length of the member.

Parallel strand lumber (PSL). A composite of wood strand elements with wood fibers primarily oriented along the length of the member.

STRUCTURAL GLUED-LAMINATED TIMBER. An engineered, stress-rated product of a timber laminating plant, comprised of assemblies of specially selected and prepared wood laminations in which the grain of all laminations is approximately parallel longitudinally and the laminations are bonded with adhesives.

SUBDIAPHRAGM. A portion of a larger wood diaphragm designed to anchor and transfer local forces to primary diaphragm struts and the main diaphragm.

TIE-DOWN (HOLD-DOWN). A device used to resist uplift of the chords of shear walls.

TREATED WOOD. Wood impregnated under pressure with compounds that reduce its susceptibility to flame spread or to deterioration caused by fungi, insects or marine borers.

WOOD SHEAR PANEL. A wood floor, roof or wall component sheathed to act as a shear wall or diaphragm.

WOOD STRUCTURAL PANEL. A panel manufactured from veneers, wood strands or wafers or a combination of veneer and wood strands or wafers bonded together with waterproof synthetic resins or other suitable bonding systems. Examples of wood structural panels are:

Composite panels. A wood structural panel that is comprised of wood veneer and reconstituted wood-based material and bonded together with waterproof adhesive;

Oriented strand board (OSB). A mat-formed wood structural panel comprised of thin rectangular wood strands arranged in cross-aligned layers with surface layers normally arranged in the long panel direction and bonded with waterproof adhesive; or

Plywood. A wood structural panel comprised of plies of wood veneer arranged in cross-aligned layers. The plies are bonded with waterproof adhesive that cures on application of heat and pressure.

SECTION 2303 MINIMUM STANDARDS AND QUALITY

2303.1 General. Structural sawn lumber; end-jointed lumber; prefabricated wood I-joists; structural glued-laminated timber; wood structural panels, fiberboard sheathing (when used structurally); hardboard siding (when used structurally); particleboard; preservative-treated wood; structural log members; structural composite lumber; round timber poles and piles; fire-retardant-treated wood; hardwood plywood; wood trusses; joist hangers; nails; and staples shall conform to the applicable provisions of this section.

2303.1.1 Sawn lumber. Sawn lumber used for load-supporting purposes, including end-jointed or edge-glued lumber, machine stress-rated or machine-evaluated lumber, shall be identified by the grade mark of a lumber grading or inspection agency that has been approved by an accreditation body that complies with DOC PS 20 or equivalent. Grading practices and identification shall comply with rules published by an agency approved in accordance with the procedures of DOC PS 20 or equivalent procedures. In lieu of a grade mark on the material, a certificate of inspection as to species and grade issued by a lumber grading or inspection agency meeting the requirements of this section is permitted to be accepted for precut, remanufactured or rough-sawn lumber and for sizes larger than 3 inches (76 mm) nominal thickness.

Approved end-jointed lumber is permitted to be used interchangeably with solid-sawn members of the same species and grade.

2303.1.2 Prefabricated wood I-joists. Structural capacities and design provisions for prefabricated wood I-joists shall be established and monitored in accordance with ASTM D 5055.

2303.1.3 Structural glued-laminated timber. Glued-laminated timbers shall be manufactured and identified as required in AITC A190.1 and ASTM D 3737.

2303.1.4 Wood structural panels. Wood structural panels, when used structurally (including those used for siding, roof and wall sheathing, subflooring, diaphragms and built-up members), shall conform to the requirements for their type in DOC PS 1 or PS 2. Each panel or member shall be identified for grade and glue type by the trademarks of an approved testing and grading agency. Wood structural panel components shall be designed and fabricated in accordance with the applicable standards listed in Section 2306.1

and identified by the trademarks of an approved testing and inspection agency indicating conformance with the applicable standard. In addition, wood structural panels when permanently exposed in outdoor applications shall be of exterior type, except that wood structural panel roof sheathing exposed to the outdoors on the underside is permitted to be interior type bonded with exterior glue, Exposure 1.

2303.1.5 Fiberboard. Fiberboard for its various uses shall conform to ASTM C 208. Fiberboard sheathing, when used structurally, shall be identified by an approved agency as conforming to ASTM C 208.

2303.1.5.1 Jointing. To ensure tight-fitting assemblies, edges shall be manufactured with square, shiplapped, beveled, tongue-and-groove or U-shaped joints.

2303.1.5.2 Roof insulation. Where used as roof insulation in all types of construction, fiberboard shall be protected with an approved roof covering.

2303.1.5.3 Wall insulation. Where installed and fireblocked to comply with Chapter 7, fiberboards are permitted as wall insulation in all types of construction. In fire walls and fire barriers, unless treated to comply with Section 803.1 for Class A materials, the boards shall be cemented directly to the concrete, masonry or other noncombustible base and shall be protected with an approved noncombustible veneer anchored to the base without intervening airspaces.

2303.1.5.3.1 Protection. Fiberboard wall insulation applied on the exterior of foundation walls shall be protected below ground level with a bituminous coating.

2303.1.6 Hardboard. Hardboard siding used structurally shall be identified by an approved agency conforming to AHA A135.6. Hardboard underlayment shall meet the strength requirements of $7/32$ -inch (5.6 mm) or $1/4$ -inch (6.4 mm) service class hardboard planed or sanded on one side to a uniform thickness of not less than 0.200 inch (5.1 mm). Prefinished hardboard paneling shall meet the requirements of AHA A135.5. Other basic hardboard products shall meet the requirements of AHA A135.4. Hardboard products shall be installed in accordance with manufacturer's recommendations.

2303.1.7 Particleboard. Particleboard shall conform to ANSI A208.1. Particleboard shall be identified by the grade mark or certificate of inspection issued by an approved agency. Particleboard shall not be utilized for applications other than indicated in this section unless the particleboard complies with the provisions of Section 2306.4.3.

2303.1.7.1 Floor underlayment. Particleboard floor underlayment shall conform to Type PBU of ANSI A208.1. Type PBU underlayment shall not be less than $1/4$ -inch (6.4 mm) thick and shall be installed in accordance with the instructions of the Composite Panel Association.

2303.1.8 Preservative-treated wood. Lumber, timber, plywood, piles and poles supporting permanent structures required by Section 2304.11 to be preservative treated shall

conform to the requirements of the applicable AWWA Standard U1 and M4 for the species, product, preservative and end use. Preservatives shall be listed in Section 4 of AWWA U1. Lumber and plywood used in wood foundation systems shall conform to Chapter 18.

2303.1.8.1 Identification. Wood required by Section 2304.11 to be preservative treated shall bear the quality mark of an inspection agency that maintains continuing supervision, testing and inspection over the quality of the preservative-treated wood. Inspection agencies for preservative-treated wood shall be listed by an accreditation body that complies with the requirements of the American Lumber Standards Treated Wood Program, or equivalent. The quality mark shall be on a stamp or label affixed to the preservative-treated wood, and shall include the following information:

1. Identification of treating manufacturer.
2. Type of preservative used.
3. Minimum preservative retention (pcf).
4. End use for which the product is treated.
5. AWWA standard to which the product was treated.
6. Identity of the accredited inspection agency.

2303.1.8.2 Moisture content. Where preservative-treated wood is used in enclosed locations where drying in service cannot readily occur, such wood shall be at a moisture content of 19 percent or less before being covered with insulation, interior wall finish, floor covering or other materials.

2303.1.9 Structural composite lumber. Structural capacities for structural composite lumber shall be established and monitored in accordance with ASTM D 5456.

2303.1.10 Structural log members. Stress grading of structural log members of nonrectangular shape, as typically used in log buildings, shall be in accordance with ASTM D 3957. Such structural log members shall be identified by the grade mark of an approved lumber grading or inspection agency. In lieu of a grade mark on the material, a certificate of inspection as to species and grade issued by a lumber grading or inspection agency meeting the requirements of this section shall be permitted.

2303.1.11 Round timber poles and piles. Round timber poles and piles shall comply with ASTM D 3200 and ASTM D 25, respectively

2303.2 Fire-retardant-treated wood. Fire-retardant-treated wood is any wood product which, when impregnated with chemicals by a pressure process or other means during manufacture, shall have, when tested in accordance with ASTM E 84, a listed flame spread index of 25 or less and show no evidence of significant progressive combustion when the test is continued for an additional 20-minute period. In addition, the flame front shall not progress more than 10.5 feet (3200 mm) beyond the centerline of the burners at any time during the test.

2303.2.1 Labeling. Fire-retardant-treated lumber and wood structural panels shall be labeled. The label shall contain the following items:

1. The identification mark of an approved agency in accordance with Section 1703.5.
2. Identification of the treating manufacturer.
3. The name of the fire-retardant treatment.
4. The species of wood treated.
5. Flame spread and smoke-developed index.
6. Method of drying after treatment.
7. Conformance with appropriate standards in accordance with Sections 2303.2.2 through 2303.2.5.
8. For fire-retardant-treated wood exposed to weather, damp or wet locations, include the words "No increase in the listed classification when subjected to the Standard Rain Test" (ASTM D 2898).

2303.2.2 Strength adjustments. Design values for untreated lumber and wood structural panels, as specified in Section 2303.1, shall be adjusted for fire-retardant-treated wood. Adjustments to design values shall be based on an approved method of investigation that takes into consideration the effects of the anticipated temperature and humidity to which the fire-retardant-treated wood will be subjected, the type of treatment and redrying procedures.

2303.2.2.1 Wood structural panels. The effect of treatment and the method of redrying after treatment, and exposure to high temperatures and high humidities on the flexure properties of fire-retardant-treated softwood plywood shall be determined in accordance with ASTM D 5516. The test data developed by ASTM D 5516 shall be used to develop adjustment factors, maximum loads and spans, or both, for untreated plywood design values in accordance with ASTM D 6305. Each manufacturer shall publish the allowable maximum loads and spans for service as floor and roof sheathing for its treatment.

2303.2.2.2 Lumber. For each species of wood that is treated, the effects of the treatment, the method of redrying after treatment and exposure to high temperatures and high humidities on the allowable design properties of fire-retardant-treated lumber shall be determined in accordance with ASTM D 5664. The test data developed by ASTM D 5664 shall be used to develop modification factors for use at or near room temperature and at elevated temperatures and humidity in accordance with ASTM D 6841. Each manufacturer shall publish the modification factors for service at temperatures of not less than 80°F (27°C) and for roof framing. The roof framing modification factors shall take into consideration the climatological location.

2303.2.3 Exposure to weather, damp or wet locations. Where fire-retardant-treated wood is exposed to weather, or damp or wet locations, it shall be identified as "Exterior" to indicate there is no increase in the listed flame

spread index as defined in Section 2303.2 when subjected to ASTM D 2898.

2303.2.4 Interior applications. Interior fire-retardant-treated wood shall have moisture content of not over 28 percent when tested in accordance with ASTM D 3201 procedures at 92-percent relative humidity. Interior fire-retardant-treated wood shall be tested in accordance with Section 2303.2.2.1 or 2303.2.2.2. Interior fire-retardant-treated wood designated as Type A shall be tested in accordance with the provisions of this section.

2303.2.5 Moisture content. Fire-retardant-treated wood shall be dried to a moisture content of 19 percent or less for lumber and 15 percent or less for wood structural panels before use. For wood kiln dried after treatment (KDAT), the kiln temperatures shall not exceed those used in kiln drying the lumber and plywood submitted for the tests described in Section 2303.2.2.1 for plywood and 2303.2.2.2 for lumber.

2303.2.6 Type I and II construction applications. See Section 603.1 for limitations on the use of fire-retardant-treated wood in buildings of Type I or II construction.

2303.3 Hardwood and plywood. Hardwood and decorative plywood shall be manufactured and identified as required in HPVA HP-1.

2303.4 Trusses.

2303.4.1 Design. Wood trusses shall be designed in accordance with the provisions of this code and accepted engineering practice. Members are permitted to be joined by nails, glue, bolts, timber connectors, metal connector plates or other approved framing devices.

2303.4.1.1 Truss designer. The individual or organization responsible for the design of trusses.

2303.4.1.2 Truss design drawings. The written, graphic and pictorial depiction of each individual truss shall be provided to the building official and approved prior to installation. Truss design drawings shall also be provided with the shipment of trusses delivered to the job site. Truss design drawings shall include, at a minimum, the information specified below:

1. Slope or depth, span and spacing;
2. Location of joints;
3. Required bearing widths;
4. Design loads as applicable;
5. Top chord live load (including snow loads);
6. Top chord dead load;
7. Bottom chord live load;
8. Bottom chord dead load;
9. Concentrated loads and their points of application as applicable;
10. Controlling wind and earthquake loads as applicable;
11. Adjustments to lumber and metal connector plate design value for conditions of use;

12. Each reaction force and direction;
13. Metal connector plate type, size, thickness or gauge, and the dimensioned location of each metal connector plate except where symmetrically located relative to the joint interface;
14. Lumber size, species and grade for each member;
15. Connection requirements for:
 - 15.1. Truss to truss;
 - 15.2. Truss ply to ply; and
 - 15.3. Field splices.
16. Calculated deflection ratio and maximum vertical and horizontal deflection for live and total load as applicable;
17. Maximum axial tension and compression forces in the truss members; and
18. Required permanent individual truss member bracing and method per Section 2303.4.1.5, unless a specific truss member permanent bracing plan for the roof or floor structural system is provided by a registered design professional.

Where required by one of the following, each individual truss design drawing shall bear the seal and signature of the truss designer:

1. Registered design professional; or
2. Building official; or
3. Statutes of the jurisdiction in which the project is to be constructed.

Exceptions:

1. When a cover sheet/truss index sheet combined into a single cover sheet is attached to the set of truss design drawings for the project, the single sheet/truss index sheet is the only document that needs to be signed and sealed within the truss submittal package.
2. When a cover sheet and a truss index sheet are separately provided and attached to the set of truss design drawings for the project, both the cover sheet and the truss index sheet are the only documents that need to be signed and sealed within the truss submittal package.

2303.4.1.3 Truss placement diagram. The truss manufacturer shall provide a truss placement diagram that identifies the proposed location for each individually designated truss and references the corresponding truss design drawing. The truss placement diagram shall be provided as part of the truss submittal package, and with the shipment of trusses delivered to the job site. Truss placement diagrams shall not be required to bear the seal or signature of the truss designer.

Exception: When the truss placement diagram is prepared under the direct supervision of a registered

design professional, it is required to be signed and sealed.

2303.4.1.4 Truss submittal package. The truss submittal package shall consist of each individual truss design drawing, the truss placement diagram for the project, the truss member permanent bracing specification and, as applicable, the cover sheet/truss index sheet.

2303.4.1.5 Truss member permanent bracing. Where permanent bracing of truss members is required on the truss design drawings, it shall be accomplished by one of the following methods:

1. The trusses shall be designed so that the buckling of any individual truss member can be resisted internally by the structure (e.g. buckling member T-bracing, L-bracing, etc.) of the individual truss. The truss individual member buckling reinforcement shall be installed as shown on the truss design drawing or on supplemental truss member buckling reinforcement diagrams provided by the truss designer.
2. Permanent bracing shall be installed using standard industry bracing details that conform with generally accepted engineering practice. Individual truss member continuous lateral bracing location(s) shall be shown on the truss design drawing.

2303.4.1.6 Anchorage. All transfer of loads and anchorage of each truss to the supporting structure is the responsibility of the registered design professional.

2303.4.1.7 Alterations to trusses. Truss members and components shall not be cut, notched, drilled, spliced or otherwise altered in any way without written concurrence and approval of a registered design professional. Alterations resulting in the addition of loads to any member (e.g., HVAC equipment, water heater) shall not be permitted without verification that the truss is capable of supporting such additional loading.

2303.4.2 Metal-plate-connected trusses. In addition to Sections 2303.4.1 through 2303.4.1.7, the design, manufacture and quality assurance of metal-plate-connected wood trusses shall be in accordance with TPI 1. Manufactured trusses shall comply with Section 1704.6 as applicable.

2303.5 Test standard for joist hangers and connectors. For the required test standards for joist hangers and connectors, see Section 1715.1.

2303.6 Nails and staples. Nails and staples shall conform to requirements of ASTM F 1667. Nails used for framing and sheathing connections shall have minimum average bending yield strengths as follows: 80 kips per square inch (ksi) (551 MPa) for shank diameters larger than 0.177 inch (4.50 mm) but not larger than 0.254 inch (6.45 mm), 90 ksi (620 MPa) for shank diameters larger than 0.142 inch (3.61 mm) but not larger than 0.177 inch (4.50 mm) and 100 ksi (689 MPa) for shank diameters of at least 0.099 inch (2.51 mm) but not larger than 0.142 inch (3.61 mm).

2303.7 Shrinkage. Consideration shall be given in design to the possible effect of cross-grain dimensional changes considered vertically which may occur in lumber fabricated in a green condition.

SECTION 2304 GENERAL CONSTRUCTION REQUIREMENTS

2304.1 General. The provisions of this section apply to design methods specified in Section 2301.2.

2304.2 Size of structural members. Computations to determine the required sizes of members shall be based on the net dimensions (actual sizes) and not nominal sizes.

2304.3 Wall framing. The framing of exterior and interior walls shall be in accordance with the provisions specified in Section 2308 unless a specific design is furnished.

2304.3.1 Bottom plates. Studs shall have full bearing on a 2-inch-thick (actual 1½-inch, 38 mm) or larger plate or sill having a width at least equal to the width of the studs.

2304.3.2 Framing over openings. Headers, double joists, trusses or other approved assemblies that are of adequate size to transfer loads to the vertical members shall be provided over window and door openings in load-bearing walls and partitions.

2304.3.3 Shrinkage. Wood walls and bearing partitions shall not support more than two floors and a roof unless an analysis satisfactory to the building official shows that shrinkage of the wood framing will not have adverse effects on the structure or any plumbing, electrical or mechanical systems, or other equipment installed therein due to excessive shrinkage or differential movements caused by shrinkage. The analysis shall also show that the roof drainage system and the foregoing systems or equipment will not be adversely affected or, as an alternate, such systems shall be designed to accommodate the differential shrinkage or movements.

2304.4 Floor and roof framing. The framing of wood-joisted floors and wood framed roofs shall be in accordance with the provisions specified in Section 2308 unless a specific design is furnished.

2304.5 Framing around flues and chimneys. Combustible framing shall be a minimum of 2 inches (51 mm), but shall not

be less than the distance specified in Sections 2111 and 2113 and the *International Mechanical Code*, from flues, chimneys and fireplaces, and 6 inches (152 mm) away from flue openings.

2304.6 Wall sheathing. Except as provided for in Section 1405 for weatherboarding or where stucco construction that complies with Section 2510 is installed, enclosed buildings shall be sheathed with one of the materials of the nominal thickness specified in Table 2304.6 or any other approved material of equivalent strength or durability.

2304.6.1 Wood structural panel sheathing. Where wood structural panel sheathing is used as the exposed finish on the exterior of outside walls, it shall have an exterior exposure durability classification. Where wood structural panel sheathing is used on the exterior of outside walls but not as the exposed finish, it shall be of a type manufactured with exterior glue (Exposure 1 or Exterior). Where wood structural panel sheathing is used elsewhere, it shall be of a type manufactured with intermediate or exterior glue.

2304.6.2 Interior paneling. Softwood wood structural panels used for interior paneling shall conform with the provisions of Chapter 8 and shall be installed in accordance with Table 2304.9.1. Panels shall comply with DOC PS 1 or PS 2. Prefinished hardboard paneling shall meet the requirements of AHA A135.5. Hardwood plywood shall conform to HPVA HP-1.

2304.7 Floor and roof sheathing.

2304.7.1 Structural floor sheathing. Structural floor sheathing shall be designed in accordance with the general provisions of this code and the special provisions in this section.

Floor sheathing conforming to the provisions of Table 2304.7(1), 2304.7(2), 2304.7(3) or 2304.7(4) shall be deemed to meet the requirements of this section.

2304.7.2 Structural roof sheathing. Structural roof sheathing shall be designed in accordance with the general provisions of this code and the special provisions in this section.

Roof sheathing conforming to the provisions of Table 2304.7(1), 2304.7(2), 2304.7(3) or 2304.7(5) shall be deemed to meet the requirements of this section. Wood structural panel roof sheathing shall be bonded by exterior glue.

**TABLE 2304.6
MINIMUM THICKNESS OF WALL SHEATHING**

SHEATHING TYPE	MINIMUM THICKNESS	MAXIMUM WALL STUD SPACING
Wood boards	$\frac{5}{8}$ inch	24 inches on center
Fiberboard	$\frac{1}{2}$ inch	16 inches on center
Wood structural panel	In accordance with Tables 2308.9.3(2) and 2308.9.3(3)	—
M-S "Exterior Glue" and —2 "Exterior Glue" Particleboard	In accordance with Tables 2306.4.3 and 2308.9.3(4)	—
Gypsum sheathing	$\frac{1}{2}$ inch	16 inches on center
Gypsum wallboard	$\frac{1}{2}$ inch	24 inches on center
Reinforced cement mortar	1 inch	24 inches on center

For SI: 1 inch = 25.4 mm.

2304.8 Lumber decking.

2304.8.1 General. Lumber decking shall be designed and installed in accordance with the general provisions of this code and the provisions of this section. Each piece shall be square-end trimmed. When random lengths are furnished, each piece shall be square-end trimmed across the face so that at least 90 percent of the pieces will be within 0.5 degrees (0.00873 rad) of square. The ends of the pieces shall be permitted to be beveled up to 2 degrees (0.0349 rad) from vertical with the exposed face of the piece slightly longer than the back of the piece. Tongue-and-groove decking shall be installed with the tongues up on sloped or pitched roofs with pattern faces down.

2304.8.2 Layup patterns. Lumber decking is permitted to be laid up following one of five standard patterns as defined in Sections 2304.8.2.1 through 2304.8.2.5. Other patterns are permitted to be used if justified by engineering analysis.

2304.8.2.1 Simple span pattern. All pieces shall be supported by two supports.

2304.8.2.2 Two-span continuous pattern. All pieces shall be supported by three supports, and all end joints shall occur in line on every other support. Supporting members shall be designed to accommodate the load redistribution caused by this pattern.

2304.8.2.3 Combination simple and two-span continuous pattern. Courses in end spans shall be alternating simple span and two span continuous. End joints are staggered in adjacent courses and occur only over supports.

2304.8.2.4 Cantilevered pieces intermixed pattern. The decking shall cover a minimum of three spans.

Pieces in the starter course and every third course shall be simple span. Pieces in other courses shall be cantilevered over the supports with end joints at alternate quarter or third points of the spans, and each piece shall bear on at least one support.

2304.8.2.5 Controlled random pattern. The decking shall cover a minimum of three spans. End joints within 6 inches (152 mm) of being in line in either direction shall be separated by at least two intervening courses. In the end bays each piece shall bear on at least one support. Where an end joint occurs in an end bay, the next piece in the same course shall continue over the first inner support for at least 24 inches (610 mm). The details of the controlled random pattern shall be as described for each decking material in Section 2304.8.3.3, 2304.8.4.3 or 2304.8.5.3.

For cantilevered spans with the controlled random pattern, special considerations shall be made when the overhang exceeds 18 inches (457 mm), 24 inches (610 mm) or 36 inches (914 mm) for 2-inch (51 mm), 3-inch (76 mm) or 4-inch (102 mm) nominal thickness decking, respectively. The maximum cantilevered length for the controlled random pattern shall be 30 percent of the length of the first adjacent interior span. For cantilever overhangs within these limits, a structural fascia shall be fastened to each decking piece to maintain a continuous, straight roof line. There shall be no end joints in the cantilevered portion or within one-half of the first adjacent interior span.

2304.8.3 Mechanically laminated decking.

2304.8.3.1 General. Mechanically laminated decking consists of square-edged dimension lumber laminations

TABLE 2304.7(1)
ALLOWABLE SPANS FOR LUMBER FLOOR AND ROOF SHEATHING^{a,b}

SPAN (inches)	MINIMUM NET THICKNESS (inches) OF LUMBER PLACED			
	Perpendicular to supports		Diagonally to supports	
	Surfaced dry ^c	Surfaced unseasoned	Surfaced dry ^c	Surfaced unseasoned
Floors				
24	$\frac{3}{4}$	$\frac{25}{32}$	$\frac{3}{4}$	$\frac{25}{32}$
16	$\frac{5}{8}$	$\frac{11}{16}$	$\frac{5}{8}$	$\frac{11}{16}$
Roofs				
24	$\frac{5}{8}$	$\frac{11}{16}$	$\frac{3}{4}$	$\frac{25}{32}$

For SI: 1 inch = 25.4 mm.

a. Installation details shall conform to Sections 2304.7.1 and 2304.7.2 for floor and roof sheathing, respectively.

b. Floor or roof sheathing conforming with this table shall be deemed to meet the design criteria of Section 2304.7.

c. Maximum 19-percent moisture content.

TABLE 2304.7(2)
SHEATHING LUMBER, MINIMUM GRADE REQUIREMENTS: BOARD GRADE

SOLID FLOOR OR ROOF SHEATHING	SPACED ROOF SHEATHING	GRADING RULES
Utility	Standard	NLGA, WCLIB, WWPA
4 common or utility	3 common or standard	NLGA, WCLIB, WWPA, NSLB or NELMA
No. 3	No. 2	SPIB
Merchantable	Construction common	RIS

set on edge and nailed to the adjacent pieces and to the supports.

2304.8.3.2 Nailing. The length of nails connecting laminations shall not be less than two and one-half times the net thickness of each lamination. Where deck supports are 48 inches (1219 mm) on center (o.c.) or less, side nails shall be spaced not more than 30 inches (762 mm) o.c. alternately near top and bottom edges, and staggered one-third of the spacing in adjacent laminations. Where supports are spaced more than 48 inches (1219 mm) o.c., side nails shall be spaced not more than 18 inches (457 mm) o.c. alternately near top and bottom edges and staggered one-third of the spacing in adjacent laminations. Two side nails shall be used at each end of butt-jointed pieces.

Laminations shall be toenailed to supports with 20d or larger common nails. Where the supports are 48 inches (1219 mm) o.c. or less, alternate laminations shall be toenailed to alternate supports; where supports are spaced more than 48 inches (1219 mm) o.c., alternate laminations shall be toenailed to every support.

2304.8.3.3 Controlled random pattern. There shall be a minimum distance of 24 inches (610 mm) between end joints in adjacent courses. The pieces in the first and second courses shall bear on at least two supports with end joints in these two courses occurring on alternate supports. A maximum of seven intervening courses shall be permitted before this pattern is repeated.

TABLE 2304.7(3)
ALLOWABLE SPANS AND LOADS FOR WOOD STRUCTURAL PANEL SHEATHING AND SINGLE-FLOOR GRADES CONTINUOUS OVER TWO OR MORE SPANS WITH STRENGTH AXIS PERPENDICULAR TO SUPPORTS^{a,b}

SHEATHING GRADES		ROOF ^c				FLOOR ^d
Panel span rating roof/floor span	Panel thickness (inches)	Maximum span (inches)		Load ^e (psf)		Maximum span (inches)
		With edge support ^f	Without edge support	Total load	Live load	
12/0	5/16	12	12	40	30	0
16/0	5/16, 3/8	16	16	40	30	0
20/0	5/16, 3/8	20	20	40	30	0
24/0	3/8, 7/16, 1/2	24	20 ^g	40	30	0
24/16	7/16, 1/2	24	24	50	40	16
32/16	15/32, 1/2, 5/8	32	28	40	30	16 ^h
40/20	19/32, 5/8, 3/4, 7/8	40	32	40	30	20 ^{h,i}
48/24	23/32, 3/4, 7/8	48	36	45	35	24
54/32	7/8, 1	54	40	45	35	32
60/32	7/8, 1 1/8	60	48	45	35	32
SINGLE FLOOR GRADES		ROOF ^c				FLOOR ^d
Panel span rating	Panel thickness (inches)	Maximum span (inches)		Load ^e (psf)		Maximum span (inches)
		With edge support ^f	Without edge support	Total load	Live load	
16 o.c.	1/2, 19/32, 5/8	24	24	50	40	16 ^h
20 o.c.	19/32, 5/8, 3/4	32	32	40	30	20 ^{h,i}
24 o.c.	23/32, 3/4	48	36	35	25	24
32 o.c.	7/8, 1	48	40	50	40	32
48 o.c.	1 3/32, 1 1/8	60	48	50	40	48

For SI: 1 inch = 25.4 mm, 1 pound per square foot = 0.0479 kN/m².

- Applies to panels 24 inches or wider.
- Floor and roof sheathing conforming with this table shall be deemed to meet the design criteria of Section 2304.7.
- Uniform load deflection limitations $1/180$ of span under live load plus dead load, $1/240$ under live load only.
- Panel edges shall have approved tongue-and-groove joints or shall be supported with blocking unless $1/4$ -inch minimum thickness underlayment or $1 1/2$ inches of approved cellular or lightweight concrete is placed over the subfloor, or finish floor is $3/4$ -inch wood strip. Allowable uniform load based on deflection of $1/360$ of span is 100 pounds per square foot except the span rating of 48 inches on center is based on a total load of 65 pounds per square foot.
- Allowable load at maximum span.
- Tongue-and-groove edges, panel edge clips (one midway between each support, except two equally spaced between supports 48 inches on center), lumber blocking or other. Only lumber blocking shall satisfy blocked diaphragm requirements.
- For $1/2$ -inch panel, maximum span shall be 24 inches.
- Span is permitted to be 24 inches on center where $3/4$ -inch wood strip flooring is installed at right angles to joist.
- Span is permitted to be 24 inches on center for floors where $1 1/2$ inches of cellular or lightweight concrete is applied over the panels.

TABLE 2304.7(4)
ALLOWABLE SPAN FOR WOOD STRUCTURAL PANEL COMBINATION SUBFLOOR-UNDERLAYMENT (SINGLE FLOOR)^{a,b}
(Panels Continuous Over Two or More Spans and Strength Axis Perpendicular to Supports)

IDENTIFICATION	MAXIMUM SPACING OF JOISTS (inches)				
	16	20	24	32	48
Species group ^c	Thickness (inches)				
1	1/2	5/8	3/4	—	—
2, 3	5/8	3/4	7/8	—	—
4	3/4	7/8	1	—	—
Single floor span rating ^d	16 o.c.	20 o.c.	24 o.c.	32 o.c.	48 o.c.

For SI: 1 inch = 25.4 mm, 1 pound per square foot = 0.0479 kN/m².

- Spans limited to value shown because of possible effects of concentrated loads. Allowable uniform loads based on deflection of $1/360$ of span is 100 pounds per square foot except allowable total uniform load for $1\frac{1}{8}$ -inch wood structural panels over joists spaced 48 inches on center is 65 pounds per square foot. Panel edges shall have approved tongue-and-groove joints or shall be supported with blocking, unless $1/4$ -inch minimum thickness underlayment or $1\frac{1}{2}$ inches of approved cellular or lightweight concrete is placed over the subfloor, or finish floor is $3/4$ -inch wood strip.
- Floor panels conforming with this table shall be deemed to meet the design criteria of Section 2304.7.
- Applicable to all grades of sanded exterior-type plywood. See DOC PS 1 for plywood species groups.
- Applicable to Underlayment grade, C-C (Plugged) plywood, and Single Floor grade wood structural panels.

TABLE 2304.7(5)
ALLOWABLE LOAD (PSF) FOR WOOD STRUCTURAL PANEL ROOF SHEATHING CONTINUOUS OVER
TWO OR MORE SPANS AND STRENGTH AXIS PARALLEL TO SUPPORTS
(Plywood Structural Panels Are Five-Ply, Five-Layer Unless Otherwise Noted)^{a,b}

PANEL GRADE	THICKNESS (inch)	MAXIMUM SPAN (inches)	LOAD AT MAXIMUM SPAN (psf)	
			Live	Total
Structural I sheathing	7/16	24	20	30
	15/32	24	35 ^c	45 ^c
	1/2	24	40 ^c	50 ^c
	19/32, 5/8	24	70	80
	23/32, 3/4	24	90	100
Sheathing, other grades covered in DOC PS 1 or DOC PS 2	7/16	16	40	50
	15/32	24	20	25
	1/2	24	25	30
	19/32	24	40 ^c	50 ^c
	5/8	24	45 ^c	55 ^c
	23/32, 3/4	24	60 ^c	65 ^c

For SI: 1 inch = 25.4 mm, 1 pound per square foot = 0.0479 kN/m².

- Roof sheathing conforming with this table shall be deemed to meet the design criteria of Section 2304.7.
- Uniform load deflection limitations $1/180$ of span under live load plus dead load, $1/240$ under live load only. Edges shall be blocked with lumber or other approved type of edge supports.
- For composite and four-ply plywood structural panel, load shall be reduced by 15 pounds per square foot.

2304.8.4 Two-inch sawn tongue-and-groove decking.

2304.8.4.1 General. Two-inch (51 mm) decking shall have a maximum moisture content of 15 percent. Decking shall be machined with a single tongue-and-groove pattern. Each deck piece shall be nailed to each support as required.

2304.8.4.2 Nailing. Each piece of decking shall be toenailed at each support with one 16d common nail through the tongue and face-nailed with one 16d common nail.

2304.8.4.3 Controlled random pattern. There shall be a minimum distance of 24 inches (610 mm) between end joints in adjacent courses. The pieces in the first and second courses shall bear on at least two supports with end joints in these two courses occurring on alternate supports. A maximum of seven intervening courses shall be permitted before this pattern is repeated.

2304.8.5 Three- and 4-inch sawn tongue-and-groove decking.

2304.8.5.1 General. Three-inch (76 mm) and 4-inch (102 mm) decking shall have a maximum moisture content of 19 percent. Decking shall be machined with a double tongue-and-groove pattern. Deck pieces shall be interconnected and fastened to the supports as required.

2304.8.5.2 Nailing. Each piece shall be toenailed at each support with one 40d common nail and face-nailed with one 60d common nail. Courses shall be spiked to each other with 8-inch (203 mm) spikes at intervals not to exceed 30 inches (762 mm) through predrilled edge holes penetrating to a depth of approximately 4 inches (102 mm) and with one spike at a distance not exceeding 10 inches (254 mm) from the end of each piece.

2304.8.5.3 Controlled random pattern. There shall be a minimum distance of 48 inches (1219 mm) between end joints in adjacent courses. Pieces not bearing over a support are permitted to occur in interior bays, provided the adjacent pieces in the same course continue over the support for at least 24 inches (610 mm). This condition shall not occur more than once in every six courses in each interior bay.

2304.9 Connections and fasteners.

2304.9.1 Fastener requirements. Connections for wood members shall be designed in accordance with the appropriate methodology in Section 2301.2. The number and size of fasteners connecting wood members shall not be less than that set forth in Table 2304.9.1.

2304.9.2 Sheathing fasteners. Sheathing nails or other approved sheathing connectors shall be driven so that their head or crown is flush with the surface of the sheathing.

2304.9.3 Joist hangers and framing anchors. Connections depending on joist hangers or framing anchors, ties and other mechanical fastenings not otherwise covered are permitted where approved. The vertical load-bearing capacity, torsional moment capacity and deflection characteristics of joist hangers shall be determined in accordance with Section 1715.1.

2304.9.4 Other fasteners. Clips, staples, glues and other approved methods of fastening are permitted where approved.

2304.9.5 Fasteners in preservative-treated and fire-retardant-treated wood. Fasteners for preservative-treated and fire-retardant-treated wood shall be of hot dipped zinc-coated galvanized steel, stainless steel, silicon bronze or copper. The coating weights for zinc-coated fasteners shall be in accordance with ASTM A 153.

Exception: Fasteners other than nails, timber rivets, wood screws and lag screws shall be permitted to be of mechanically deposited zinc coated steel with coating weights in accordance with ASTM B 695, Class 55 minimum.

Fastenings for wood foundations shall be as required in AF&PA Technical Report No. 7.

2304.9.6 Load path. Where wall framing members are not continuous from foundation sill to roof, the members shall be secured to ensure a continuous load path. Where required, sheet metal clamps, ties or clips shall be formed of galvanized steel or other approved corrosion-resistant material not less than 0.040 inch (1.01 mm) nominal thickness.

2304.9.7 Framing requirements. Wood columns and posts shall be framed to provide full end bearing. Alternatively, column-and-post end connections shall be designed to resist the full compressive loads, neglecting end-bearing capacity. Column-and-post end connections shall be fastened to resist lateral and net induced uplift forces.

2304.10 Heavy timber construction.

2304.10.1 Columns. Columns shall be continuous or superimposed throughout all stories by means of reinforced concrete or metal caps with brackets, or shall be connected by properly designed steel or iron caps, with pintles and base plates, or by timber splice plates affixed to the columns by metal connectors housed within the contact faces, or by other approved methods.

2304.10.1.1 Column connections. Girders and beams shall be closely fitted around columns and adjoining ends shall be cross tied to each other, or intertied by caps or ties, to transfer horizontal loads across joints. Wood bolsters shall not be placed on tops of columns unless the columns support roof loads only.

2304.10.2 Floor framing. Approved wall plate boxes or hangers shall be provided where wood beams, girders or trusses rest on masonry or concrete walls. Where intermediate beams are used to support a floor, they shall rest on top of girders, or shall be supported by ledgers or blocks securely fastened to the sides of the girders, or they shall be supported by an approved metal hanger into which the ends of the beams shall be closely fitted.

2304.10.3 Roof framing. Every roof girder and at least every alternate roof beam shall be anchored to its supporting member; and every monitor and every sawtooth construction shall be anchored to the main roof construction. Such anchors shall consist of steel or iron bolts of sufficient strength to resist vertical uplift of the roof.

**TABLE 2304.9.1
FASTENING SCHEDULE**

CONNECTION	FASTENING ^{a,m}	LOCATION
1. Joist to sill or girder	3 - 8d common (2½" × 0.131") 3 - 3" × 0.131" nails 3 - 3" 14 gauge staples	toenail
2. Bridging to joist	2 - 8d common (2½" × 0.131") 2 - 3" × 0.131" nails 2 - 3" 14 gauge staples	toenail each end
3. 1" × 6" subfloor or less to each joist	2 - 8d common (2½" × 0.131")	face nail
4. Wider than 1" × 6" subfloor to each joist	3 - 8d common (2½" × 0.131")	face nail
5. 2" subfloor to joist or girder	2 - 16d common (3½" × 0.162")	blind and face nail
6. Sole plate to joist or blocking Sole plate to joist or blocking at braced wall panel	16d (3½" × 0.135") at 16" o.c. 3" × 0.131" nails at 8" o.c. 3" 14 gauge staples at 12" o.c. 3" - 16d (3½" × 0.135") at 16" 4 - 3" × 0.131" nails at 16" 4 - 3" 14 gauge staples per 16"	typical face nail braced wall panels
7. Top plate to stud	2 - 16d common (3½" × 0.162") 3 - 3" × 0.131" nails 3 - 3" 14 gauge staples	end nail
8. Stud to sole plate	4 - 8d common (2½" × 0.131") 4 - 3" × 0.131" nails 3 - 3" 14 gauge staples 2 - 16d common (3½" × 0.162") 3 - 3" × 0.131" nails 3 - 3" 14 gauge staples	toenail end nail
9. Double studs	16d (3½" × 0.135") at 24" o.c. 3" × 0.131" nail at 8" o.c. 3" 14 gauge staple at 8" o.c.	face nail
10. Double top plates Double top plates	16d (3½" × 0.135") at 16" o.c. 3" × 0.131" nail at 12" o.c. 3" 14 gauge staple at 12" o.c. 8-16d common (3½" × 0.162") 12-3" × 0.131" nails 12-3" 14 gauge staples	typical face nail lap splice
11. Blocking between joists or rafters to top plate	3 - 8d common (2½" × 0.131") 3 - 3" × 0.131" nails 3 - 3" 14 gauge staples	toenail
12. Rim joist to top plate	8d (2½" × 0.131") at 6" o.c. 3" × 0.131" nail at 6" o.c. 3" 14 gauge staple at 6" o.c.	toenail
13. Top plates, laps and intersections	2 - 16d common (3½" × 0.162") 3 - 3" × 0.131" nails 3 - 3" 14 gauge staples	face nail
14. Continuous header, two pieces	16d common (3½" × 0.162")	16" o.c. along edge
15. Ceiling joists to plate	3 - 8d common (2½" × 0.131") 5 - 3" × 0.131" nails 5 - 3" 14 gauge staples	toenail
16. Continuous header to stud	4 - 8d common (2½" × 0.131")	toenail

(continued)

**TABLE 2304.9.1—continued
FASTENING SCHEDULE**

CONNECTION	FASTENING ^{a,m}	LOCATION
17. Ceiling joists, laps over partitions (see Section 2308.10.4.1, Table 2308.10.4.1)	3 - 16d common (3½" × 0.162") minimum, Table 2308.10.4.1 4 - 3" × 0.131" nails 4 - 3" 14 gauge staples	face nail
18. Ceiling joists to parallel rafters (see Section 2308.10.4.1, Table 2308.10.4.1)	3 - 16d common (3½" × 0.162") minimum, Table 2308.10.4.1 4 - 3" × 0.131" nails 4 - 3" 14 gauge staples	face nail
19. Rafter to plate (see Section 2308.10.1, Table 2308.10.1)	3 - 8d common (2½" × 0.131") 3 - 3" × 0.131" nails 3 - 3" 14 gauge staples	toenail
20. 1" diagonal brace to each stud and plate	2 - 8d common (2½" × 0.131") 2 - 3" × 0.131" nails 3 - 3" 14 gauge staples	face nail
21. 1" × 8" sheathing to each bearing	3 - 8d common (2½" × 0.131")	face nail
22. Wider than 1" × 8" sheathing to each bearing	3 - 8d common (2½" × 0.131")	face nail
23. Built-up corner studs	16d common (3½" × 0.162") 3" × 0.131" nails 3" 14 gauge staples	24" o.c. 16" o.c. 16" o.c.
24. Built-up girder and beams	20d common (4" × 0.192") 32" o.c. 3" × 0.131" nail at 24" o.c. 3" 14 gauge staple at 24" o.c. 2 - 20d common (4" × 0.192") 3 - 3" × 0.131" nails 3 - 3" 14 gauge staples	face nail at top and bottom staggered on opposite sides face nail at ends and at each splice
25. 2" planks	16d common (3½" × 0.162")	at each bearing
26. Collar tie to rafter	3 - 10d common (3" × 0.148") 4 - 3" × 0.131" nails 4 - 3" 14 gauge staples	face nail
27. Jack rafter to hip	3 - 10d common (3" × 0.148") 4 - 3" × 0.131" nails 4 - 3" 14 gauge staples 2 - 16d common (3½" × 0.162") 3 - 3" × 0.131" nails 3 - 3" 14 gauge staples	toenail face nail
28. Roof rafter to 2-by ridge beam	2 - 16d common (3½" × 0.162") 3 - 3" × 0.131" nails 3 - 3" 14 gauge staples 2-16d common (3½" × 0.162") 3 - 3" × 0.131" nails 3 - 3" 14 gauge staples	toenail face nail
29. Joist to band joist	3 - 16d common (3½" × 0.162") 4 - 3" × 0.131" nails 4 - 3" 14 gauge staples	face nail

(continued)

**TABLE 2304.9.1—continued
FASTENING SCHEDULE**

CONNECTION	FASTENING ^{a,m}	LOCATION
30. Ledger strip	3 - 16d common (3 ¹ / ₂ " × 0.162") 4 - 3" × 0.131" nails 4 - 3" 14 gauge staples	face nail
31. Wood structural panels and particleboard ^b Subfloor, roof and wall sheathing (to framing)	1/2" and less 6d ^{c,1} 2 3/8" × 0.113" nail ⁿ 1 3/4" 16 gauge ^o 19/32" to 3/4" 8d ^d or 6d ^e 2 3/8" × 0.113" nail ^p 2" 16 gauge ^p 7/8" to 1" 8d ^c 1 1/8" to 1 1/4" 10d ^d or 8d ^d	
Single Floor (combination subfloor-underlayment to framing)	3/4" and less 6d ^e 7/8" to 1" 8d ^e 1 1/8" to 1 1/4" 10d ^d or 8d ^e	
32. Panel siding (to framing)	1/2" or less 6d ^f 5/8" 8d ^f	
33. Fiberboard sheathing ^g	1/2" No. 11 gauge roofing nail ^h 6d common nail (2" × 0.113") No. 16 gauge staple ⁱ 25/32" No. 11 gauge roofing nail ^h 8d common nail (2 1/2" × 0.131") No. 16 gauge staple ⁱ	
34. Interior paneling	1/4" 4d ^j 3/8" 6d ^k	

For SI: 1 inch = 25.4 mm.

- a. Common or box nails are permitted to be used except where otherwise stated.
- b. Nails spaced at 6 inches on center at edges, 12 inches at intermediate supports except 6 inches at supports where spans are 48 inches or more. For nailing of wood structural panel and particleboard diaphragms and shear walls, refer to Section 2305. Nails for wall sheathing are permitted to be common, box or casing.
- c. Common or deformed shank (6d - 2" × 0.113"; 8d - 2 1/2" × 0.131"; 10d - 3" × 0.148").
- d. Common (6d - 2" × 0.113"; 8d - 2 1/2" × 0.131"; 10d - 3" × 0.148").
- e. Deformed shank (6d - 2" × 0.113"; 8d - 2 1/2" × 0.131"; 10d - 3" × 0.148").
- f. Corrosion-resistant siding (6d - 1 7/8" × 0.106"; 8d - 2 3/8" × 0.128") or casing (6d - 2" × 0.099"; 8d - 2 1/2" × 0.113") nail.
- g. Fasteners spaced 3 inches on center at exterior edges and 6 inches on center at intermediate supports, when used as structural sheathing. Spacing shall be 6 inches on center on the edges and 12 inches on center at intermediate supports for nonstructural applications.
- h. Corrosion-resistant roofing nails with 7/16-inch-diameter head and 1 1/2-inch length for 1/2-inch sheathing and 1 3/4-inch length for 25/32-inch sheathing.
- i. Corrosion-resistant staples with nominal 7/16-inch crown and 1 1/8-inch length for 1/2-inch sheathing and 1 1/2-inch length for 25/32-inch sheathing. Panel supports at 16 inches (20 inches if strength axis in the long direction of the panel, unless otherwise marked).
- j. Casing (1 1/2" × 0.080") or finish (1 1/2" × 0.072") nails spaced 6 inches on panel edges, 12 inches at intermediate supports.
- k. Panel supports at 24 inches. Casing or finish nails spaced 6 inches on panel edges, 12 inches at intermediate supports.
- l. For roof sheathing applications, 8d nails (2 1/2" × 0.113") are the minimum required for wood structural panels.
- m. Staples shall have a minimum crown width of 7/16 inch.
- n. For roof sheathing applications, fasteners spaced 4 inches on center at edges, 8 inches at intermediate supports.
- o. Fasteners spaced 4 inches on center at edges, 8 inches at intermediate supports for subfloor and wall sheathing and 3 inches on center at edges, 6 inches at intermediate supports for roof sheathing.
- p. Fasteners spaced 4 inches on center at edges, 8 inches at intermediate supports.

2304.10.4 Floor decks. Floor decks and covering shall not extend closer than $\frac{1}{2}$ inch (12.7 mm) to walls. Such $\frac{1}{2}$ -inch (12.7 mm) spaces shall be covered by a molding fastened to the wall either above or below the floor and arranged such that the molding will not obstruct the expansion or contraction movements of the floor. Corbeling of masonry walls under floors is permitted in place of such molding.

2304.10.5 Roof decks. Where supported by a wall, roof decks shall be anchored to walls to resist uplift forces determined in accordance with Chapter 16. Such anchors shall consist of steel or iron bolts of sufficient strength to resist vertical uplift of the roof.

2304.11 Protection against decay and termites.

2304.11.1 General. Where required by this section, protection from decay and termites shall be provided by the use of naturally durable or preservative-treated wood.

2304.11.2 Wood used above ground. Wood used above ground in the locations specified in Sections 2304.11.2.1 through 2304.11.2.7, 2304.11.3 and 2304.11.5 shall be naturally durable wood or preservative-treated wood using water-borne preservatives, in accordance with AWPA U1 (Commodity Specifications A or F) for above-ground use.

2304.11.2.1 Joists, girders and subfloor. Where wood joists or the bottom of a wood structural floor without joists are closer than 18 inches (457 mm), or wood girders are closer than 12 inches (305 mm) to the exposed ground in crawl spaces or unexcavated areas located within the perimeter of the building foundation, the floor assembly (including posts, girders, joists and subfloor) shall be of naturally durable or preservative-treated wood.

2304.11.2.2 Wood supported by exterior foundation walls. Wood framing members, including wood sheathing, that rest on exterior foundation walls and are less than 8 inches (203 mm) from exposed earth shall be of naturally durable or preservative-treated wood.

2304.11.2.3 Exterior walls below grade. Wood framing members and furring strips attached directly to the interior of exterior masonry or concrete walls below grade shall be of approved naturally durable or preservative-treated wood.

2304.11.2.4 Sleepers and sills. Sleepers and sills on a concrete or masonry slab that is in direct contact with earth shall be of naturally durable or preservative-treated wood.

2304.11.2.5 Girder ends. The ends of wood girders entering exterior masonry or concrete walls shall be provided with a $\frac{1}{2}$ -inch (12.7 mm) air space on top, sides and end, unless naturally durable or preservative-treated wood is used.

2304.11.2.6 Wood siding. Clearance between wood siding and earth on the exterior of a building shall not be less than 6 inches (152 mm) except where siding, sheathing

and wall framing are of naturally durable or preservative-treated wood.

2304.11.2.7 Posts or columns. Posts or columns supporting permanent structures and supported by a concrete or masonry slab or footing that is in direct contact with the earth shall be of naturally durable or preservative-treated wood.

Exceptions:

1. Posts or columns that are either exposed to the weather or located in basements or cellars, supported by concrete piers or metal pedestals projected at least 1 inch (25 mm) above the slab or deck and 6 inches (152 mm) above exposed earth, and are separated therefrom by an impervious moisture barrier.
2. Posts or columns in enclosed crawl spaces or unexcavated areas located within the periphery of the building, supported by a concrete pier or metal pedestal at a height greater than 8 inches (203 mm) from exposed ground, and are separated therefrom by an impervious moisture barrier.

2304.11.3 Laminated timbers. The portions of glued-laminated timbers that form the structural supports of a building or other structure and are exposed to weather and not fully protected from moisture by a roof, eave or similar covering shall be pressure treated with preservative or be manufactured from naturally durable or preservative-treated wood.

2304.11.4 Wood in contact with the ground or fresh water. Wood used in contact with the ground (exposed earth) in the locations specified in Sections 2304.11.4.1 and 2304.11.4.2 shall be naturally durable (species for both decay and termite resistance) or preservative treated using water-borne preservatives in accordance with AWPA U1 (Commodity Specifications A or F) for soil or fresh water use.

Exception: Untreated wood is permitted where such wood is continuously and entirely below the ground-water level or submerged in fresh water.

2304.11.4.1 Posts or columns. Posts and columns supporting permanent structures that are embedded in concrete that is in direct contact with the earth, embedded in concrete that is exposed to the weather or in direct contact with the earth shall be of preservative-treated wood.

2304.11.4.2 Wood structural members. Wood structural members that support moisture-permeable floors or roofs that are exposed to the weather, such as concrete or masonry slabs, shall be of naturally durable or preservative-treated wood unless separated from such floors or roofs by an impervious moisture barrier.

2304.11.5 Supporting member for permanent appurtenances. Naturally durable or preservative-treated wood shall be utilized for those portions of wood members that form the structural supports of buildings, balconies, porches or similar permanent building appurtenances where such members are exposed to the weather without adequate pro-

tection from a roof, eave, overhang or other covering to prevent moisture or water accumulation on the surface or at joints between members.

Exception: When a building is located in a geographical region where experience has demonstrated that climatic conditions preclude the need to use durable materials where the structure is exposed to the weather.

2304.11.6 Termite protection. In geographical areas where hazard of termite damage is known to be very heavy, wood floor framing shall be of naturally durable species (termite resistant) or preservative treated in accordance with AWPA U1 for the species, product preservative and end use or provided with approved methods of termite protection.

2304.11.7 Wood used in retaining walls and cribs. Wood installed in retaining or crib walls shall be preservative treated in accordance with AWPA U1 (Commodity Specifications A or F) for soil and fresh water use.

2304.11.8 Attic ventilation. For attic ventilation, see Section 1203.2.

2304.11.9 Under-floor ventilation (crawl space). For under-floor ventilation (crawl space), see Section 1203.3.

2304.12 Long-term loading. Wood members supporting concrete, masonry or similar materials shall be checked for the effects of long-term loading using the provisions of the AF&PA NDS. The total deflection, including the effects of long-term loading, shall be limited in accordance with Section 1604.3.1 for these supported materials.

Exception: Horizontal wood members supporting masonry or concrete nonstructural floor or roof surfacing not more than 4 inches (102 mm) thick need not be checked for long-term loading.

SECTION 2305 GENERAL DESIGN REQUIREMENTS FOR LATERAL-FORCE-RESISTING SYSTEMS

2305.1 General. Structures using wood shear walls and diaphragms to resist wind, seismic and other lateral loads shall be designed and constructed in accordance with the provisions of this section. Alternatively, compliance with the AF&PA SDPWS shall be permitted subject to the limitations therein and the limitations of this code.

2305.1.1 Shear resistance based on principles of mechanics. Shear resistance of diaphragms and shear walls are permitted to be calculated by principles of mechanics using values of fastener strength and sheathing shear resistance.

2305.1.2 Framing. Boundary elements shall be provided to transmit tension and compression forces. Perimeter members at openings shall be provided and shall be detailed to distribute the shearing stresses. Diaphragm and shear wall sheathing shall not be used to splice boundary elements. Diaphragm chords and collectors shall be placed in, or tangent to, the plane of the diaphragm framing unless it can be demonstrated that the moments, shears and deformations, considering eccentricities resulting from other configurations can be tolerated without exceeding the adjusted resistance and drift limits.

2305.1.2.1 Framing members. Framing members shall be at least 2 inch (51 mm) nominal width. In general, adjoining panel edges shall bear and be attached to the framing members and butt along their centerlines. Nails shall be placed not less than $\frac{3}{8}$ inch (9.5 mm) from the panel edge, not more than 12 inches (305 mm) apart along intermediate supports, and 6 inches (152 mm) along panel edge bearings, and shall be firmly driven into the framing members.

2305.1.3 Openings in shear panels. Openings in shear panels that materially affect their strength shall be fully detailed on the plans, and shall have their edges adequately reinforced to transfer all shearing stresses.

2305.1.4 Shear panel connections. Positive connections and anchorages capable of resisting the design forces shall be provided between the shear panel and the attached components. In Seismic Design Category D, E or F, the capacity of toenail connections shall not be used when calculating lateral load resistance to transfer lateral earthquake forces in excess of 150 pounds per foot (2189 N/m) from diaphragms to shear walls, drag struts (collectors) or other elements, or from shear walls to other elements.

2305.1.5 Wood members resisting horizontal seismic forces contributed by masonry and concrete walls. Wood shear walls, diaphragms, horizontal trusses and other members shall not be used to resist horizontal seismic forces contributed by masonry or concrete walls in structures over one story in height.

Exceptions:

1. Wood floor and roof members are permitted to be used in horizontal trusses and diaphragms to resist horizontal seismic forces contributed by masonry or concrete walls, provided such forces do not result in torsional force distribution through the truss or diaphragm.
2. Wood structural panel sheathed shear walls are permitted to be used to provide resistance to seismic forces contributed by masonry or concrete walls in two-story structures of masonry or concrete walls, provided the following requirements are met:
 - 2.1. Story-to-story wall heights shall not exceed 12 feet (3658 mm).
 - 2.2. Diaphragms shall not be designed to transmit lateral forces by rotation and shall not cantilever past the outermost supporting shear wall.
 - 2.3. Combined deflections of diaphragms and shear walls shall not permit story drift of supported masonry or concrete walls to exceed the limit of Section 12.12.1 in ASCE 7.
 - 2.4. Wood structural panel sheathing in diaphragms shall have unsupported edges blocked. Wood structural panel sheathing for both stories of shear walls shall have unsupported edges blocked and, for the

lower story, shall have a minimum thickness of $1\frac{5}{32}$ inch (11.9 mm).

2.5. There shall be no out-of-plane horizontal offsets between the first and second stories of wood structural panel shear walls.

2305.1.6 Wood members resisting seismic forces from nonstructural concrete or masonry. Wood members shall be permitted to resist horizontal seismic forces from nonstructural concrete, masonry veneer or concrete floors.

2305.2 Design of wood diaphragms.

2305.2.1 General. Wood diaphragms are permitted to be used to resist horizontal forces provided the deflection in the plane of the diaphragm, as determined by calculations, tests or analogies drawn therefrom, does not exceed the permissible deflection of attached distributing or resisting elements. Connections shall extend into the diaphragm a sufficient distance to develop the force transferred into the diaphragm.

2305.2.2 Deflection. Permissible deflection shall be that deflection up to which the diaphragm and any attached distributing or resisting element will maintain its structural integrity under design load conditions, such that the resisting element will continue to support design loads without danger to occupants of the structure. Calculations for diaphragm deflection shall account for the usual bending and shear components as well as any other factors, such as nail deformation, which will contribute to deflection.

The deflection (Δ) of a blocked wood structural panel diaphragm uniformly nailed throughout is permitted to be calculated by using the following equation. If not uniformly nailed, the constant 0.188 (For SI: $1/1627$) in the third term must be modified accordingly.

$$\Delta = \frac{5vL^3}{8EAb} + \frac{vL}{4Gt} + 0.188Le_n + \frac{\Sigma(\Delta_c X)}{2b} \quad \text{(Equation 23-1)}$$

$$\text{For SI: } \Delta = \frac{0.052vL^3}{EAb} + \frac{vL}{4Gt} + \frac{Le_n}{1627} + \frac{\Sigma(\Delta_c X)}{2b}$$

where:

- A = Area of chord cross section, in square inches (mm²).
- b = Diaphragm width, in feet (mm).
- E = Elastic modulus of chords, in pounds per square inch (N/mm²).
- e_n = Nail or staple deformation, in inches (mm) [see Table 2305.2.2(1)].
- Gt = Panel rigidity through the thickness, in pounds per inch (N/mm) of panel width or depth [see Table 2305.2.2(2)].
- L = Diaphragm length, in feet (mm).
- v = Maximum shear due to design loads in the direction under consideration, in pounds per linear foot (plf) (N/mm).
- Δ = The calculated deflection, in inches (mm).

$\Sigma(\Delta_c X)$ = Sum of individual chord-splice slip values on both sides of the diaphragm, each multiplied by its distance to the nearest support.

2305.2.3 Diaphragm aspect ratios. Size and shape of dia-

TABLE 2305.2.2(1)
e_n VALUES (inches) FOR USE IN CALCULATING DIAPHRAGM DEFLECTION DUE TO FASTENER SLIP (Structural I)^{a,d}

LOAD PER FASTENER ^c (pounds)	FASTENER DESIGNATIONS ^b			
	6d	8d	10d	14-Ga staple x 2 inches long
60	0.01	0.00	0.00	0.011
80	0.02	0.01	0.01	0.018
100	0.03	0.01	0.01	0.028
120	0.04	0.02	0.01	0.04
140	0.06	0.03	0.02	0.053
160	0.10	0.04	0.02	0.068
180	—	0.05	0.03	—
200	—	0.07	0.47	—
220	—	0.09	0.06	—
240	—	—	0.07	—

For SI: 1 inch = 25.4 mm, 1 foot = 304.8 mm, 1 pound = 4.448 N.

- a. Increase e_n values 20 percent for plywood grades other than Structural I.
- b. Nail values apply to common wire nails or staples identified.
- c. Load per fastener = maximum shear per foot divided by the number of fasteners per foot at interior panel edges.
- d. Decrease e_n values 50 percent for seasoned lumber (moisture content < 19 percent).

phragms shall be limited as set forth in Table 2305.2.3.

TABLE 2305.2.3
MAXIMUM DIAPHRAGM DIMENSION RATIOS
HORIZONTAL AND SLOPED DIAPHRAGM

TYPE	MAXIMUM LENGTH - WIDTH RATIO
Wood structural panel, nailed all edges	4:1
Wood structural panel, blocking omitted at intermediate joints	3:1
Diagonal sheathing, single	3:1
Diagonal sheathing, double	4:1

2305.2.4 Construction. Wood diaphragms shall be constructed of wood structural panels manufactured with exterior glue and not less than 4 feet by 8 feet (1219 mm by 2438 mm), except at boundaries and changes in framing where minimum sheet dimension shall be 24 inches (610 mm) unless all edges of the undersized sheets are supported by and fastened to framing members or blocking. Wood structural panel thickness for horizontal diaphragms shall not be less than the values set forth in Tables 2304.7(3), 2304.7(4) and 2304.7(5) for corresponding joist spacing and loads.

TABLE 2305.2.2(2)
VALUES OF G_t FOR USE IN CALCULATING DEFLECTION OF WOOD STRUCTURAL PANEL SHEAR WALLS AND DIAPHRAGMS

PANEL TYPE	SPAN RATING	VALUES OF G_t (lb/in. panel depth or width)							
		OTHER				STRUCTURAL I			
		3-ply Plywood	4-ply Plywood	5-ply Plywood ^a	OSB	3-ply Plywood	4-ply Plywood	5-ply Plywood ^a	OSB
Sheathing	24/0	25,000	32,500	37,500	77,500	32,500	42,500	41,500	77,500
	24/16	27,000	35,000	40,500	83,500	35,000	45,500	44,500	83,500
	32/16	27,000	35,000	40,500	83,500	35,000	45,500	44,500	83,500
	40/20	28,500	37,000	43,000	88,500	37,000	48,000	47,500	88,500
	48/24	31,000	40,500	46,500	96,000	40,500	52,500	51,000	96,000
Single Floor	16 o.c.	27,000	35,000	40,500	83,500	35,000	45,500	44,500	83,500
	20 o.c.	28,000	36,500	42,000	87,000	36,500	47,500	46,000	87,000
	24 o.c.	30,000	39,000	45,000	93,000	39,000	50,500	49,500	93,000
	32 o.c.	36,000	47,000	54,000	110,000	47,000	61,000	59,500	110,000
	48 o.c.	50,500	65,500	76,000	155,000	65,500	85,000	83,500	155,000

	Thickness (in.)	OTHER			STRUCTURAL I		
		A-A, A-C	Marine	All Other Grades	A-A, A-C	Marine	All Other Grades
Sanded Plywood	1/4	24,000	31,000	24,000	31,000	31,000	31,000
	1 1/32	25,500	33,000	25,500	33,000	33,000	33,000
	3/8	26,000	34,000	26,000	34,000	34,000	34,000
	1 5/32	38,000	49,500	38,000	49,500	49,500	49,500
	1/2	38,500	50,000	38,500	50,000	50,000	50,000
	1 9/32	49,000	63,500	49,000	63,500	63,500	63,500
	5/8	49,500	64,500	49,500	64,500	64,500	64,500
	2 3/32	50,500	65,500	50,500	65,500	65,500	65,500
	3/4	51,000	66,500	51,000	66,500	66,500	66,500
	7/8	52,500	68,500	52,500	68,500	68,500	68,500
	1	73,500	95,500	73,500	95,500	95,500	95,500
	1 1/8	75,000	97,500	75,000	97,500	97,500	97,500

For SI: 1 inch = 25.4 mm, 1 pound/inch = 0.1751 N/mm.

a. Applies to plywood with five or more layers; for five-ply/three-layer plywood, use values for four ply.

2305.2.4.1 Seismic Design Category F. Structures assigned to Seismic Design Category F shall conform to the additional requirements of this section.

Wood structural panel sheathing used for diaphragms and shear walls that are part of the seismic-force-resisting system shall be applied directly to the framing members.

Exception: Wood structural panel sheathing in a diaphragm is permitted to be fastened over solid lumber planking or laminated decking, provided the panel joints and lumber planking or laminated decking joints do not coincide.

2305.2.5 Rigid diaphragms. Design of structures with rigid diaphragms shall conform to the structure configuration requirements of Section 12.3.2 of ASCE 7 and the horizontal shear distribution requirements of Section 12.8.4 of ASCE 7.

Open-front structures with rigid wood diaphragms resulting in torsional force distribution are permitted, provided the length, l , of the diaphragm normal to the open side does not exceed 25 feet (7620 mm), the diaphragm sheathing conforms to Section 2305.2.4 and the l/w ratio [as shown in Figure 2305.2.5(1)] is less than 1 for one-story structures or 0.67 for structures over one story in height.

Exception: Where calculations show that diaphragm deflections can be tolerated, the length, l , normal to the open end is permitted to be increased to a l/w ratio not greater than 1.5 where sheathed in compliance with Section 2305.2.4 or to 1 where sheathed in compliance with Section 2306.3.4 or 2306.3.5.

Rigid wood diaphragms are permitted to cantilever past the outermost supporting shearwall (or other vertical resisting element) a length, l , of not more than 25 feet (7620 mm) or two-thirds of the diaphragm width, w , whichever is smaller. Figure 2305.2.5(2) illustrates the dimensions of l and w for a cantilevered diaphragm.

Structures with rigid wood diaphragms having a torsional irregularity in accordance with Table 12.3-1, Item 1, of ASCE 7 shall meet the following requirements: the l/w ratio shall not exceed 1 for one-story structures or 0.67 for struc-

tures over one story in height, where l is the dimension parallel to the load direction for which the irregularity exists.

Exception: Where calculations demonstrate that the diaphragm deflections can be tolerated, the width is permitted to be increased and the l/w ratio is permitted to be increased to 1.5 where sheathed in compliance with Section 2305.2.4 or 1 where sheathed in compliance with Section 2306.3.4 or 2306.3.5.

2305.3 Design of wood shear walls.

2305.3.1 General. Wood shear walls are permitted to resist horizontal forces in vertical distributing or resisting elements, provided the deflection in the plane of the shear wall, as determined by calculations, tests or analogies drawn therefrom, does not exceed the more restrictive of the permissible deflection of attached distributing or resisting elements or the drift limits of Section 12.12.1 of ASCE 7. Shear wall sheathing other than wood structural panels shall not be permitted in Seismic Design Category E or F (see Section 1613).

2305.3.2 Deflection. Permissible deflection shall be that deflection up to which the shear wall and any attached distributing or resisting element will maintain its structural integrity under design load conditions, i.e., continue to support design loads without danger to occupants of the structure.

The deflection (Δ) of a blocked wood structural panel shear wall uniformly fastened throughout is permitted to be calculated by the use of the following equation:

$$\Delta = \frac{8vh^3}{EAb} + \frac{vh}{Gt} + 0.75he_n + d_a \frac{h}{b} \quad (\text{Equation 23-2})$$

$$\text{For SI: } \Delta = \frac{vh^3}{3EAb} + \frac{vh}{Gt} + \frac{he_n}{407.6} + d_a \frac{h}{b}$$

where:

A = Area of boundary element cross section in square inches (mm²) (vertical member at shear wall boundary).

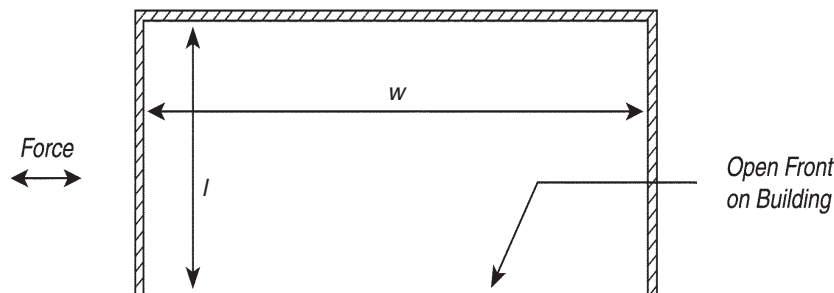

FIGURE 2305.2.5(1)
DIAPHRAGM LENGTH AND WIDTH FOR PLAN VIEW OF OPEN-FRONT BUILDING

- b = Wall width, in feet (mm).
- d_a = Vertical elongation of overturning anchorage (including fastener slip, device elongation, anchor rod elongation, etc.) at the design shear load (v).
- E = Elastic modulus of boundary element (vertical member at shear wall boundary), in pounds per square inch (N/mm²).
- e_n = Nail or staple deformation, in inches (mm) [see Table 2305.2.2(1)].
- Gt = Panel rigidity through the thickness, in pounds per inch (N/mm) of panel width or depth [see Table 2305.2.2(2)].
- h = Wall height, in feet (mm).
- v = Maximum shear due to design loads at the top of the wall, in pounds per linear foot (N/mm).
- Δ = The calculated deflection, in inches (mm).

2305.3.3 Construction. Wood shear walls shall be constructed of wood structural panels manufactured with exterior glue and not less than 4 feet by 8 feet (1219 mm by 2438 mm), except at boundaries and at changes in framing. All edges of all panels shall be supported by and fastened to framing members or blocking. Wood structural panel thickness for shear walls shall not be less than set forth in Table 2304.6.1 for corresponding framing spacing and loads, except that 1/4 inch (6.4 mm) is permitted to be used where perpendicular loads permit.

2305.3.4 Shear wall aspect ratios. Size and shape of shear walls, perforated shear wall segments within perforated shear walls and wall piers within shear walls that are designed for force transfer around openings shall be limited as set forth in Table 2305.3.4. The height, h , and the width, w , shall be determined in accordance with Sections 2305.3.5 through 2305.3.5.2 and 2305.3.6 through 2305.3.6.2, respectively.

**TABLE 2305.3.4
MAXIMUM SHEAR WALL DIMENSION RATIOS**

TYPE	MAXIMUM HEIGHT-WIDTH RATIO
Wood structural panels or particleboard, nailed edges	For other than seismic: 3 1/2:1 For seismic: 2:1 ^a
Diagonal sheathing, single	2:1
Fiberboard	1 1/2:1
Gypsum board, gypsum lath, cement plaster	1 1/2:1 ^b

- a. For design to resist seismic forces, shear wall height-width ratios greater than 2:1, but not exceeding 3 1/2:1, are permitted provided the allowable shear values in Table 2306.4.1 are multiplied by $2w/h$.
- b. Ratio shown is for unblocked construction. Height-to-width ratio is permitted to be 2:1 where the wall is installed as blocked construction in accordance with Section 2306.4.5.1.2.

2305.3.5 Shear wall height definition. The height of a shear wall, h , shall be defined as:

1. The maximum clear height from the top of the foundation to the bottom of the diaphragm framing above; or
2. The maximum clear height from the top of the diaphragm to the bottom of the diaphragm framing above [see Figure 2305.3.5(a)].

2305.3.5.1 Perforated shear wall segment height definition. The height of a perforated shear wall segment, h , shall be defined as specified in Section 2305.3.5 for shear walls.

2305.3.5.2 Force transfer shear wall pier height definition. The height, h , of a wall pier in a shear wall with openings designed for force transfer around openings shall be defined as the clear height of the pier at the side of an opening [see Figure 2305.3.5(b)].

2305.3.6 Shear wall width definition. The width of a shear wall, w , shall be defined as the sheathed dimension of the shear wall in the direction of application of force [see Figure 2305.3.5(a)].

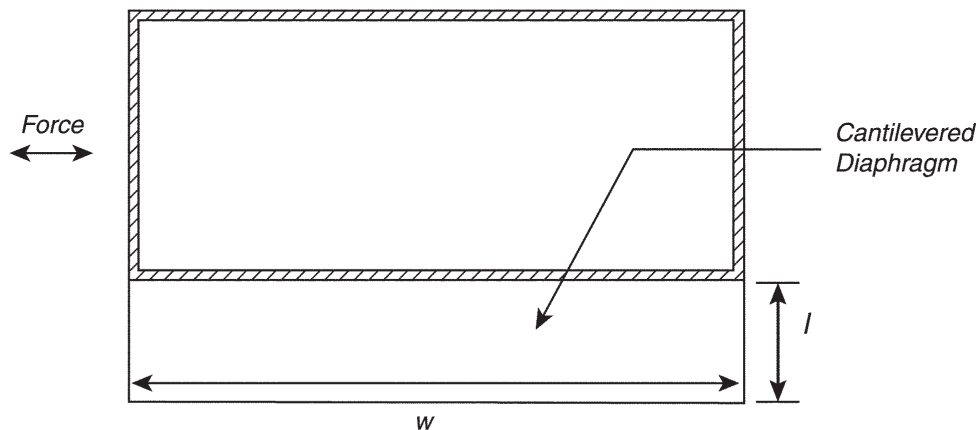

**FIGURE 2305.2.5(2)
DIAPHRAGM LENGTH AND WIDTH FOR PLAN VIEW OF CANTILEVERED DIAPHRAGM**

2305.3.6.1 Perforated shear wall segment width definition. The width of a perforated shear wall segment, w , shall be defined as the width of full-height sheathing adjacent to openings in the perforated shear wall [see Figure 2305.3.5(a)].

2305.3.6.2 Force transfer shear wall pier width definition. The width, w , of a wall pier in a shear wall with openings designed for force transfer around openings shall be defined as the sheathed width of the pier at the side of an opening [see Figure 2305.3.5(b)].

2305.3.7 Overturning restraint. Where the dead load stabilizing moment in accordance with Chapter 16 allowable stress design load combinations is not sufficient to prevent uplift due to overturning moments on the wall, an anchoring device shall be provided. Anchoring devices shall maintain a continuous load path to the foundation.

2305.3.8 Shear walls with openings. The provisions of this section shall apply to the design of shear walls with openings. Where framing and connections around the openings are designed for force transfer around the openings, the provisions of Section 2305.3.8.1 shall apply. Where framing and connections around the openings are not designed for force transfer around the openings, the provisions of Section 2305.3.8.2 shall apply.

2305.3.8.1 Force transfer around openings. Where shear walls with openings are designed for force transfer around the openings, the limitations of Table 2305.3.4 shall apply to the overall shear wall, including openings, and to each wall pier at the side of an opening. Design for

force transfer shall be based on a rational analysis. Detailing of boundary elements around the opening shall be provided in accordance with the provisions of this section [see Figure 2305.3.5(b)].

2305.3.8.2 Perforated shear walls. The provisions of Section 2305.3.8.2 shall be permitted to be used for the design of perforated shear walls. For the determination of the height and width of perforated shear wall segments, see Sections 2305.3.5.1 and 2305.3.6.1, respectively.

2305.3.8.2.1 Limitations. The following limitations shall apply to the use of Section 2305.3.8.2:

1. A perforated shear wall segment shall be located at each end of a perforated shear wall. Openings shall be permitted to occur beyond the ends of the perforated shear wall, provided the width of such openings is not included in the width of the perforated shear wall.
2. The allowable shear set forth in Table 2306.4.1 shall not exceed 490 plf (7150 N/m).
3. Where out-of-plane offsets occur, portions of the wall on each side of the offset shall be considered as separate perforated shear walls.
4. Collectors for shear transfer shall be provided through the full length of the perforated shear wall.
5. A perforated shear wall shall have uniform top of wall and bottom of wall elevations. Perfo-

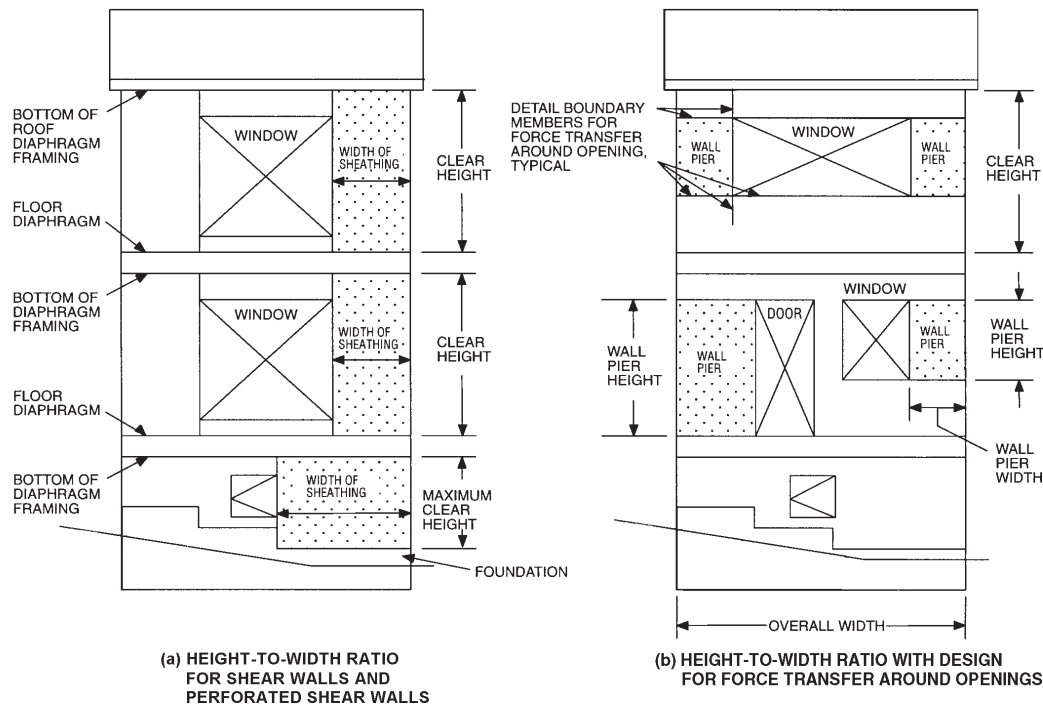

FIGURE 2305.3.5
GENERAL DEFINITION OF SHEAR WALL HEIGHT, WIDTH AND HEIGHT-TO-WIDTH RATIO

rated shear walls not having uniform elevations shall be designed by other methods.

- 6. Perforated shear wall height, *h*, shall not exceed 20 feet (6096 mm).

2305.3.8.2.2 Perforated shear wall resistance. The resistance of a perforated shear wall shall be calculated in accordance with the following:

1. The percentage of full-height sheathing shall be calculated as the sum of the widths of perforated shear wall segments divided by the total width of the perforated shear wall, including openings.
2. The maximum opening height shall be taken as the maximum opening clear height. Where areas above and below an opening remain unsheathed, the height of the opening shall be defined as the height of the wall.
3. The unadjusted shear resistance shall be the allowable shear set forth in Table 2306.4.1 for height-to-width ratios of perforated shear wall segments that do not exceed 2:1 for seismic forces and 3 1/2:1 for other than seismic forces. For seismic forces, where the height-to-width ratio of any perforated shear wall segment used in the calculation of the sum of the widths of perforated shear wall segments, $\sum L_i$, is greater than 2:1 but does not exceed 3 1/2:1, the unadjusted shear resistance shall be multiplied by 2 *w/h*.
4. The adjusted shear resistance shall be calculated by multiplying the unadjusted shear resistance by the shear resistance adjustment factors

of Table 2305.3.8.2. For intermediate percentages of full-height sheathing, the values in Table 2305.3.8.2 are permitted to be interpolated.

- 5. The perforated shear wall resistance shall be equal to the adjusted shear resistance times the sum of the widths of the perforated shear wall segments.

2305.3.8.2.3 Anchorage and load path. Design of perforated shear wall anchorage and load path shall conform to the requirements of Sections 2305.3.8.2.4 through 2305.3.8.2.8, or shall be calculated using principles of mechanics. Except as modified by these sections, wall framing, sheathing, sheathing attachment and fastener schedules shall conform to the requirements of Section 2305.2.4 and Table 2306.4.1.

2305.3.8.2.4 Uplift anchorage at perforated shear wall ends. Anchorage for uplift forces due to overturning shall be provided at each end of the perforated shear wall. The uplift anchorage shall conform to the requirements of Section 2305.3.7, except that for each story the minimum tension chord uplift force, *T*, shall be calculated in accordance with the following:

$$T = \frac{Vh}{C_o \sum L_i} \quad \text{(Equation 23-3)}$$

where:

- T* = Tension chord uplift force, pounds (N).
- V* = Shear force in perforated shear wall, pounds (N).

**TABLE 2305.3.8.2
SHEAR RESISTANCE ADJUSTMENT FACTOR, *C_o***

WALL HEIGHT, H	MAXIMUM OPENING HEIGHT ^a				
	H/3	H/2	2H/3	5H/6	H
8' wall	2'-8"	4'-0"	5'-4"	6'-8"	8'-0"
10' wall	3'-4"	5'-0"	6'-8"	8'-4"	10'-0"
Percentage of full-height sheathing ^b	Shear resistance adjustment factor				
10%	1.00	0.69	0.53	0.43	0.36
20%	1.00	0.71	0.56	0.45	0.38
30%	1.00	0.74	0.59	0.49	0.42
40%	1.00	0.77	0.63	0.53	0.45
50%	1.00	0.80	0.67	0.57	0.50
60%	1.00	0.83	0.71	0.63	0.56
70%	1.00	0.87	0.77	0.69	0.63
80%	1.00	0.91	0.83	0.77	0.71
90%	1.00	0.95	0.91	0.87	0.83
100%	1.00	1.00	1.00	1.00	1.00

For SI: 1 inch = 25.4 mm, 1 foot = 304.8 mm.

- a. See Section 2305.3.8.2.2, Item 2.
- b. See Section 2305.3.8.2.2, Item 1.

h = Perforated shear wall height, feet (mm).

C_o = Shear resistance adjustment factor from Table 2305.3.8.2.

$\sum L_i$ = Sum of widths of perforated shear wall segments, feet (mm).

2305.3.8.2.5 Anchorage for in-plane shear. The unit shear force, v , transmitted into the top of a perforated shear wall, out of the base of the perforated shear wall at full height sheathing and into collectors connecting shear wall segments shall be calculated in accordance with the following:

$$v = \frac{V}{C_o \sum L_i} \quad \text{(Equation 23-4)}$$

where:

v = Unit shear force, pounds per lineal feet (N/m).

V = Shear force in perforated shear wall, pounds (N).

C_o = Shear resistance adjustment factor from Table 2305.3.8.2.

$\sum L_i$ = Sum of widths of perforated shear wall segments, feet (mm).

2305.3.8.2.6 Uplift anchorage between perforated shear wall ends. In addition to the requirements of Section 2305.3.8.2.4, perforated shear wall bottom plates at full-height sheathing shall be anchored for a uniform uplift force, t , equal to the unit shear force, v , determined in Section 2305.3.8.2.5.

2305.3.8.2.7 Compression chords. Each end of each perforated shear wall segment shall be designed for a compression chord force, C , equal to the tension chord uplift force, T , calculated in Section 2305.3.8.2.4.

2305.3.8.2.8 Load path. Load path. A load path to the foundation shall be provided for each uplift force, T and t , for each shear force, V and v , and for each compression chord force, C . Elements resisting shear wall forces contributed by multiple stories shall be designed for the sum of forces contributed by each story.

2305.3.8.2.9 Deflection of shear walls with openings. The controlling deflection of a blocked shear wall with openings uniformly fastened throughout shall be taken as the maximum individual deflection of the shear wall segments calculated in accordance with Section 2305.3.2, divided by the appropriate shear resistance adjustment factors of Table 2305.3.8.2.

2305.3.9 Summing shear capacities. The shear values for shear panels of different capacities applied to the same side of the wall are not cumulative except as allowed in Table 2306.4.1.

The shear values for material of the same type and capacity applied to both faces of the same wall are cumulative. Where the material capacities are not equal, the

allowable shear shall be either two times the smaller shear capacity or the capacity of the stronger side, whichever is greater.

Summing shear capacities of dissimilar materials applied to opposite faces or to the same wall line is not allowed.

Exception: For wind design, the allowable shear capacity of shear wall segments sheathed with a combination of wood structural panels and gypsum wallboard on opposite faces, fiberboard structural sheathing and gypsum wallboard on opposite faces or hardboard panel siding and gypsum wallboard on opposite faces shall equal the sum of the sheathing capacities of each face separately.

2305.3.10 Adhesives. Adhesive attachment of shear wall sheathing is not permitted as a substitute for mechanical fasteners, and shall not be used in shear wall strength calculations alone, or in combination with mechanical fasteners in Seismic Design Category D, E or F.

2305.3.11 Sill plate size and anchorage in Seismic Design Category D, E or F. Anchor bolts for shear walls shall include steel plate washers, a minimum of 0.229 inch by 3 inches by 3 inches (5.82 mm by 76 mm by 76 mm) in size, between the sill plate and nut. The hole in the plate washer is permitted to be diagonally slotted with a width of up to $3/16$ inch (4.76 mm) larger than the bolt diameter and a slot length not to exceed $1\ 3/4$ inches (44 mm), provided a standard cut washer is placed between the plate washer and the nut. Sill plates resisting a design load greater than 490 plf (7154 N/m) using load and resistance factor design or 350 plf (5110 N/m) using allowable stress design shall not be less than a 3-inch (76 mm) nominal member. Where a single 3-inch (76 mm) nominal sill plate is used, 2-20d box end nails shall be substituted for 2-16d common end nails found in line 8 of Table 2304.9.1.

Exception: In shear walls where the design load is greater than 490 plf (7151 N/m) but less than 840 plf (12 264 N/m) using load and resistance factor design or greater than 350 plf (5110 N/m) but less than 600 plf (8760 N/m) using allowable stress design, the sill plate is permitted to be a 2-inch (51 mm) nominal member if the sill plate is anchored by two times the number of bolts required by design and 0.229-inch by 3-inch by 3-inch (5.82 mm by 76 mm by 76 mm) plate washers are used.

SECTION 2306 ALLOWABLE STRESS DESIGN

2306.1 Allowable stress design. The structural analysis and construction of wood elements in structures using allowable stress design shall be in accordance with the following applicable standards:

American Forest & Paper Association.

NDS National Design Specification for Wood Construction

American Institute of Timber Construction.

AITC 104 Typical Construction Details

AITC 110	Standard Appearance Grades for Structural Glued Laminated Timber
AITC 113	Standard for Dimensions of Structural Glued Laminated Timber
AITC 117	Standard Specifications for Structural Glued Laminated Timber of Softwood Species
AITC 119	Structural Standard Specifications for Glued Laminated Timber of Hardwood Species
AITC A190.1	Structural Glued Laminated Timber
AITC 200	Inspection Manual

American Society of Agricultural Engineers.

ASAE EP 484.2	Diaphragm Design of Metal-Clad, Post-Frame Rectangular Buildings
ASAE EP 486.1	Shallow Post Foundation Design
ASAE 559	Design Requirements and Bending Properties for Mechanically Laminated Columns

APA—The Engineered Wood Association.

Panel Design Specification

Plywood Design Specification Supplement 1 - Design & Fabrication of Plywood Curved Panel	
Plywood Design Specification Supplement 2 - Design & Fabrication of Glued Plywood-Lumber Beams	
Plywood Design Specification Supplement 3 - Design & Fabrication of Plywood Stressed-Skin Panels	
Plywood Design Specification Supplement 4 - Design & Fabrication of Plywood Sandwich Panels	
Plywood Design Specification Supplement 5 - Design & Fabrication of All-Plywood Beams	
EWS T300	Glulam Connection Details
EWS S560	Field Notching and Drilling of Glued Laminated Timber Beams
EWS S475	Glued Laminated Beam Design Tables
EWS X450	Glulam in Residential Construction
EWS X440	Product and Application Guide: Glulam
EWS R540	Builders Tips: Proper Storage and Handling of Glulam Beams

Truss Plate Institute, Inc.

TPI 1	National Design Standard for Metal Plate Connected Wood Truss Construction
-------	--

2306.1.1 Joists and rafters. The design of rafter spans is permitted to be in accordance with the *AF&PA Span Tables for Joists and Rafters*.

2306.1.2 Plank and beam flooring. The design of plank and beam flooring is permitted to be in accordance with the *AF&PA Wood Construction Data No. 4*.

2306.1.3 Treated wood stress adjustments. The allowable unit stresses for preservative-treated wood need no adjustment for treatment, but are subject to other adjustments.

The allowable unit stresses for fire-retardant-treated wood, including fastener values, shall be developed from an

approved method of investigation that considers the effects of anticipated temperature and humidity to which the fire-retardant-treated wood will be subjected, the type of treatment and the redrying process. Other adjustments are applicable except that the impact load duration shall not apply.

2306.1.4 Lumber decking. The capacity of lumber decking arranged according to the patterns described in Section 2304.8.2 shall be the lesser of the capacities determined for flexure and deflection according to the formulas in Table 2306.1.4.

TABLE 2306.1.4
ALLOWABLE LOADS FOR LUMBER DECKING

PATTERN	ALLOWABLE AREA LOAD ^{a,b}	
	Flexure	Deflection
Simple span	$\sigma_b = \frac{8F'_b d^2}{l^2} \frac{d^2}{6}$	$\sigma_\Delta = \frac{384\Delta E' d^3}{5l^4} \frac{d^3}{12}$
Two-span continuous	$\sigma_b = \frac{8F'_b d^2}{l^2} \frac{d^2}{6}$	$\sigma_\Delta = \frac{185\Delta E' d^3}{l^4} \frac{d^3}{12}$
Combination simple- and two-span continuous	$\sigma_b = \frac{8F'_b d^2}{l^2} \frac{d^2}{6}$	$\sigma_\Delta = \frac{131\Delta E' d^3}{l^4} \frac{d^3}{12}$
Cantilevered pieces intermixed	$\sigma_b = \frac{20F'_b d^2}{3l^2} \frac{d^2}{6}$	$\sigma_\Delta = \frac{105\Delta E' d^3}{l^4} \frac{d^3}{12}$
Controlled random layup		
Mechanically laminated decking	$\sigma_b = \frac{20F'_b d^2}{3l^2} \frac{d^2}{6}$	$\sigma_\Delta = \frac{100\Delta E' d^3}{l^4} \frac{d^3}{12}$
2-inch decking	$\sigma_b = \frac{20F'_b d^2}{3l^2} \frac{d^2}{6}$	$\sigma_\Delta = \frac{100\Delta E' d^3}{l^4} \frac{d^3}{12}$
3-inch and 4-inch decking	$\sigma_b = \frac{20F'_b d^2}{3l^2} \frac{d^2}{6}$	$\sigma_\Delta = \frac{116\Delta E' d^3}{l^4} \frac{d^3}{12}$

For SI: 1 inch = 25.4 mm.

a. σ_b = Allowable total uniform load limited by bending.

σ_Δ = Allowable total uniform load limited by deflection.

b. d = Actual decking thickness.

l = Span of decking.

F'_b = Allowable bending stress adjusted by applicable factors.

E' = Modulus of elasticity adjusted by applicable factors.

2306.2 Wind provisions for walls.

2306.2.1 Wall stud bending stress increase. The AF&PA NDS fiber stress in bending (F_b) design values for sawn lumber wood studs resisting out of plane wind loads shall be increased by the factors in Table 2306.2.1, in lieu of the 1.15 repetitive member factor. These increases take into consideration the load sharing and composite actions provided by the wood structural panels as defined in Section 2302.1. The increases shall apply where the studs are designed for bending and are spaced no more than 16 inches (406 mm) o.c.,

covered on the inside with a minimum of $1/2$ -inch (12.7 mm) gypsum board fastened in accordance with Table 2306.4.5 and sheathed on the exterior with a minimum of $3/8$ -inch (9.5 mm) wood structural panel sheathing. All panel joints shall occur over studs or blocking and shall be attached using a minimum of 8d common nails spaced a maximum of 6 inches o.c. (152 mm) at panel edges and 12 inches o.c. (305 mm) at intermediate framing members.

**TABLE 2306.2.1
WALL STUD BENDING STRESS INCREASE FACTORS**

STUD SIZE	SYSTEM FACTOR
2 × 4	1.5
2 × 6	1.35
2 × 8	1.25
2 × 10	1.2
2 × 12	1.15

2306.3 Wood diaphragms.

2306.3.1 Wood structural panel diaphragms. Wood structural panel diaphragms are permitted to resist horizontal forces using the allowable shear capacities set forth in Table 2306.3.1 or 2306.3.2. The allowable shear capacities are permitted to be calculated by principles of mechanics without limitations by using values for fastener strength in the AF&PA NDS, structural design properties for wood structural panels based on DOC PS-1 and DOC PS-2 or wood structural panel design properties given in the *APA Panel Design Specification (PDS)*.

2306.3.2 Shear capacities modifications. The allowable shear capacities in Tables 2306.3.1 and 2306.3.2 for horizontal wood structural panel diaphragms shall be increased 40 percent for wind design.

2306.3.3 Diagonally sheathed lumber diaphragms. Diagonally sheathed lumber diaphragms shall be nailed in accordance with Table 2306.3.3.

2306.3.4 Single diagonally sheathed lumber diaphragms. Single diagonally sheathed lumber diaphragms shall be constructed of minimum 1-inch (25 mm) thick nominal sheathing boards laid at an angle of approximately 45 degrees (0.78 rad) to the supports. The shear capacity for single diagonally sheathed lumber diaphragms of southern pine or Douglas fir-larch shall not exceed 300 plf (4378 N/m) of width. The shear capacities shall be adjusted by reduction factors of 0.82 for framing members of species with a specific gravity equal to or greater than 0.42 but less

than 0.49 and 0.65 for species with a specific gravity of less than 0.42, as contained in the AF&PA NDS.

2306.3.4.1 End joints. End joints in adjacent boards shall be separated by at least one stud or joist space and there shall be at least two boards between joints on the same support.

2306.3.4.2 Single diagonally sheathed lumber diaphragms. Single diagonally sheathed lumber diaphragms made up of 2-inch (51 mm) nominal diagonal lumber sheathing fastened with 16d nails shall be designed with the same shear capacities as shear panels using 1-inch (25 mm) boards fastened with 8d nails, provided there are not splices in adjacent boards on the same support and the supports are not less than 4 inch (102 mm) nominal depth or 3 inch (76 mm) nominal thickness.

2306.3.5 Double diagonally sheathed lumber diaphragms. Double diagonally sheathed lumber diaphragms shall be constructed of two layers of diagonal sheathing boards at 90 degrees (1.57 rad) to each other on the same face of the supporting members. Each chord shall be considered as a beam with uniform load per foot equal to 50 percent of the unit shear due to diaphragm action. The load shall be assumed as acting normal to the chord in the plan of the diaphragm in either direction. The span of the chord or portion thereof shall be the distance between framing members of the diaphragm, such as the joists, studs and blocking that serve to transfer the assumed load to the sheathing. The shear capacity of double diagonally sheathed diaphragms of Southern pine or Douglas fir-larch shall not exceed 600 plf (8756 kN/m) of width. The shear capacity shall be adjusted by reduction factors of 0.82 for framing members of species with a specific gravity equal to or greater than 0.42 but less than 0.49 and 0.65 for species with a specific gravity of less than 0.42, as contained in the AF&PA NDS. Nailing of diagonally sheathed lumber diaphragms shall be in accordance with Table 2306.3.3.

2306.3.6 Gypsum board diaphragm ceilings. Gypsum board diaphragm ceilings shall be in accordance with Section 2508.5.

2306.4 Shear walls. Panel sheathing joints in shear walls shall occur over studs or blocking. Adjacent panel sheathing joints shall occur over and be nailed to common framing members (see Section 2305.3.1 for limitations on shear wall bracing materials).

**TABLE 2306.3.3
DIAGONALLY SHEATHED LUMBER DIAPHRAGM NAILING SCHEDULE**

SHEATHING NOMINAL DIMENSION	NAILING TO INTERMEDIATE AND END-BEARING STUDS		NAILING AT THE SHEAR PANEL BOUNDARIES	
	Type, size and number of nails per board			
	Common nails	Box nails	Common nails	Box nails
1 × 6	2 - 8d	3 - 8d	3 - 8d	5 - 8d
1 × 8	3 - 8d	4 - 8d	4 - 8d	6 - 8d
2 × 6	2 - 16d	3 - 16d	3 - 16d	5 - 16d
2 × 8	3 - 16d	4 - 16d	4 - 16d	6 - 16d

TABLE 2306.3.1
 ALLOWABLE SHEAR (POUNDS PER FOOT) FOR WOOD STRUCTURAL PANEL DIAPHRAGMS WITH
 FRAMING OF DOUGLAS FIR-LARCH, OR SOUTHERN PINE^a FOR WIND OR SEISMIC LOADING^h

PANEL GRADE	COMMON NAIL SIZE OR STAPLE LENGTH AND GAUGE	MINIMUM FASTENER PENETRATION IN FRAMING (inches)	MINIMUM NOMINAL PANEL THICKNESS (inch)	MINIMUM NOMINAL WIDTH OF FRAMING MEMBERS AT ADJOINING PANEL EDGES AND BOUNDARIES ^g (inches)	BLOCKED DIAPHRAGMS						UNBLOCKED DIAPHRAGMS			
					Fastener spacing (inches) at diaphragm boundaries (all cases) at continuous panel edges parallel to load (Cases 3, 4), and at all panel edges (Cases 5, 6) ^b						Fasteners spaced 6" max. at supported edges ^b			
					Fastener spacing (inches) at other panel edges (Cases 1, 2, 3 and 4) ^b									
					6	4	2 1/2 ^c	2 ^c	Case 1 (No unblocked edges or continuous joints parallel to load)		All other configurations (Cases 2, 3, 4, 5 and 6)			
Structural I Grades	6d ^c (2" x 0.113")	1 1/4	5/16	2	6	4	2 1/2 ^c	2 ^c	6	6		6	6	165
					250	375	420	210	280	420	475	185	140	
	1 1/2 16 Gauge	1	5/16	2	6	4	2 1/2 ^c	2 ^c	6	6	6	6	135	105
					205	310	350	155	205	310	350	135	105	
	8d (2 1/2" x 0.131)	1 3/8	3/8	2	6	4	2 1/2 ^c	2 ^c	6	6	6	6	240	180
					360	530	600	270	360	400	600	240	180	
	1 1/2 16 Gauge	1	3/8	2	6	4	2 1/2 ^c	2 ^c	6	6	6	6	155	115
					235	350	400	175	235	350	400	155	115	
	10d ^d (3" x 0.148")	1 1/2	15/32	2	6	4	2 1/2 ^c	2 ^c	6	6	6	6	175	130
					265	395	450	200	265	395	450	175	130	
	1 1/2 16 Gauge	1	15/32	2	6	4	2 1/2 ^c	2 ^c	6	6	6	6	285	215
					425	640	730	320	425	640	730	285	215	
6d ^c (2" x 0.113)	1 1/4	5/16	2	6	4	2 1/2 ^c	2 ^c	6	6	6	6	320	240	
				480	720	820	360	480	720	820	320	240		
1 1/2 16 Gauge	1	5/16	2	6	4	2 1/2 ^c	2 ^c	6	6	6	6	155	120	
				235	350	400	175	235	350	400	155	120		
6d ^c (2" x 0.113)	1 1/4	5/16	2	6	4	2 1/2 ^c	2 ^c	6	6	6	6	175	130	
				265	395	450	200	265	395	450	175	130		
1 1/2 16 Gauge	1	5/16	2	6	4	2 1/2 ^c	2 ^c	6	6	6	6	150	110	
				225	335	380	170	225	335	380	150	110		
6d ^c (2" x 0.113)	1 1/4	5/16	2	6	4	2 1/2 ^c	2 ^c	6	6	6	6	170	125	
				250	380	430	190	250	380	430	170	125		
1 1/2 16 Gauge	1	5/16	2	6	4	2 1/2 ^c	2 ^c	6	6	6	6	125	90	
				185	275	315	140	185	275	315	125	90		
6d ^c (2" x 0.113)	1 1/4	5/16	2	6	4	2 1/2 ^c	2 ^c	6	6	6	6	140	105	
				205	310	350	155	205	310	350	140	105		
8d (2 1/2" x 0.131)	1 3/8	3/8	2	6	4	2 1/2 ^c	2 ^c	6	6	6	6	165	125	
				250	375	420	185	250	375	420	165	125		
8d (2 1/2" x 0.131)	1 3/8	3/8	2	6	4	2 1/2 ^c	2 ^c	6	6	6	6	185	140	
				280	420	475	210	280	420	475	185	140		
8d (2 1/2" x 0.131)	1 3/8	3/8	2	6	4	2 1/2 ^c	2 ^c	6	6	6	6	215	160	
				320	480	545	240	320	480	545	215	160		
8d (2 1/2" x 0.131)	1 3/8	3/8	3	6	4	2 1/2 ^c	2 ^c	6	6	6	6	240	180	
				360	540	610	270	360	540	610	240	180		

(continued)

TABLE 2306.3.1—continued
 ALLOWABLE SHEAR (POUNDS PER FOOT) FOR WOOD STRUCTURAL PANEL DIAPHRAGMS WITH
 FRAMING OF DOUGLAS FIR-LARCH, OR SOUTHERN PINE^a FOR WIND OR SEISMIC LOADING^b

PANEL GRADE	COMMON NAIL SIZE OR STAPLE ^f LENGTH AND GAUGE	MINIMUM FASTENER PENETRATION IN FRAMING (inches)	MINIMUM NOMINAL PANEL THICKNESS (inch)	MINIMUM NOMINAL WIDTH OF FRAMING MEMBERS AT ADJOINING PANEL EDGES AND BOUNDARIES ^g (inches)	BLOCKED DIAPHRAGMS						UNBLOCKED DIAPHRAGMS			
					Fastener spacing (inches) at diaphragm boundaries (all cases) at continuous panel edges parallel to load (Cases 3, 4), and at all panel edges (Cases 5, 6) ^b						Fasteners spaced 6" max. at supported edges ^b		Case 1 (No unblocked edges or continuous joints parallel to load)	All other configurations (Cases 2, 3, 4, 5 and 6)
					6	4	2 1/2 ^c	2 ^c	Fastener spacing (inches) at other panel edges (Cases 1, 2, 3 and 4) ^b					
					6	6	4	3	6	4	3			
Sheathing, single floor and other grades covered in DOC PS 1 and PS 2 (continued)	1 1/2 16 Gauge	1	3/8	2	160	210	315	360	140	105				
	8d (2 1/2" x 0.131")	1 3/8	7/16	3	180	235	355	400	160	120				
	1 1/2 16 Gauge	1		2	255	340	505	575	230	170				
	8d (2 1/2" x 0.131")	1 3/8	7/16	3	285	380	570	645	255	190				
	1 1/2 16 Gauge	1		2	165	225	335	380	150	110				
	8d (2 1/2" x 0.131")	1 3/8	15/32	3	190	250	375	425	165	125				
	10d ^d (3" x 0.148")	1 1/2		2	270	360	530	600	240	180				
	1 1/2 16 Gauge	1	19/32	3	300	400	600	675	265	200				
	10d ^d (3" x 0.148")	1 1/2		2	290	385	575	655	255	190				
	1 1/2 16 Gauge	1	19/32	3	325	430	650	735	290	215				
	10d ^d (3" x 0.148")	1 1/2		2	160	210	315	360	140	105				
	1 3/4 16 Gauge	1	19/32	3	180	235	355	405	160	120				
10d ^d (3" x 0.148")	1 1/2	2		320	425	640	730	285	215					
1 3/4 16 Gauge	1	19/32	3	360	480	720	820	320	240					
10d ^d (3" x 0.148")	1 1/2		2	175	235	350	400	155	115					
1 3/4 16 Gauge	1	19/32	3	200	265	395	450	175	130					
10d ^d (3" x 0.148")	1 1/2		2	320	425	640	730	285	215					

(continued)

TABLE 2306.3.1—continued
ALLOWABLE SHEAR (POUNDS PER FOOT) FOR WOOD STRUCTURAL
PANEL DIAPHRAGMS WITH FRAMING OF DOUGLAS FIR-LARCH,
OR SOUTHERN PINE^a FOR WIND OR SEISMIC LOADING^h

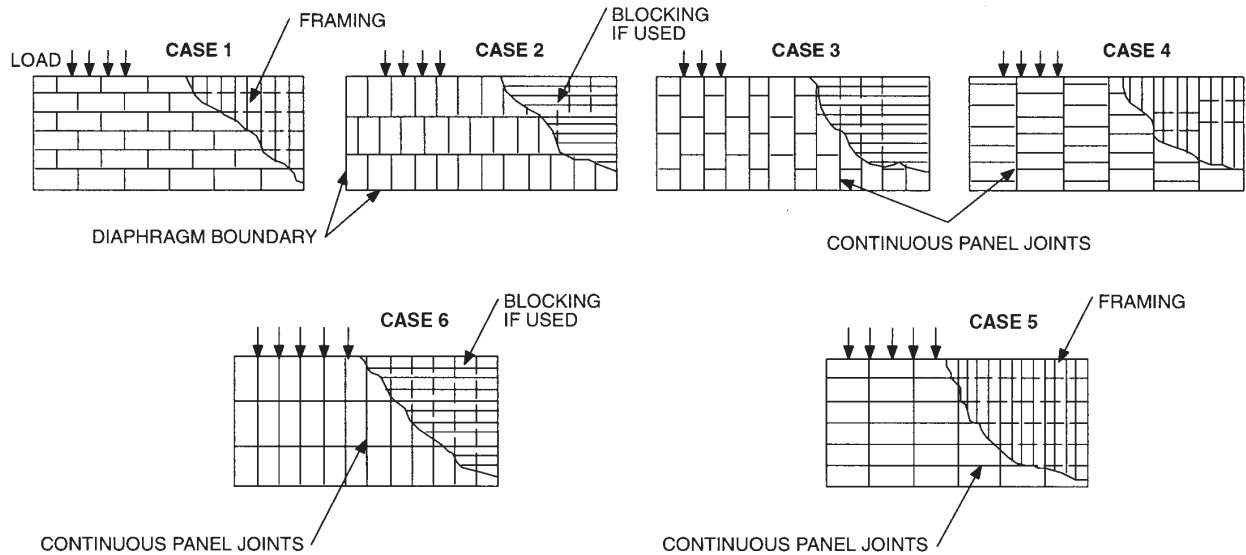

For SI: 1 inch = 25.4 mm, 1 pound per foot = 14.5939 N/m.

- For framing of other species: (1) Find specific gravity for species of lumber in AF&PA NDS. (2) For staples find shear value from table above for Structural I panels (regardless of actual grade) and multiply value by 0.82 for species with specific gravity of 0.42 or greater, or 0.65 for all other species. (3) For nails find shear value from table above for nail size for actual grade and multiply value by the following adjustment factor: Specific Gravity Adjustment Factor = $[1 - (0.5 - SG)]$, where SG = Specific Gravity of the framing lumber. This adjustment factor shall not be greater than 1.
- Space fasteners maximum 12 inches o.c. along intermediate framing members (6 inches o.c. where supports are spaced 48 inches o.c.).
- Framing at adjoining panel edges shall be 3 inches nominal or wider, and nails shall be staggered where nails are spaced 2 inches o.c. or $2\frac{1}{2}$ inches o.c.
- Framing at adjoining panel edges shall be 3 inches nominal or wider, and nails shall be staggered where both of the following conditions are met: (1) 10d nails having penetration into framing of more than $1\frac{1}{2}$ inches and (2) nails are spaced 3 inches o.c. or less.
- 8d is recommended minimum for roofs due to negative pressures of high winds.
- Staples shall have a minimum crown width of $\frac{7}{16}$ inch and shall be installed with their crowns parallel to the long dimension of the framing members.
- The minimum nominal width of framing members not located at boundaries or adjoining panel edges shall be 2 inches.
- For shear loads of normal or permanent load duration as defined by the AF&PA NDS, the values in the table above shall be multiplied by 0.63 or 0.56, respectively.

**TABLE 2306.3.2
ALLOWABLE SHEAR (POUNDS PER FOOT) FOR WOOD STRUCTURAL PANEL BLOCKED DIAPHRAGMS
UTILIZING MULTIPLE ROWS OF FASTENERS (HIGH LOAD DIAPHRAGMS) WITH FRAMING OF
DOUGLAS FIR-LARCH OR SOUTHERN PINE^a FOR WIND OR SEISMIC LOADING^{b, g, h}**

PANEL GRADE ^e	COMMON NAIL SIZE OR STAPLE ^f gauge	MINIMUM FASTENER PENETRATION IN FRAMING (inches)	MINIMUM NOMINAL PANEL THICKNESS (inch)	MINIMUM NOMINAL WIDTH OF FRAMING MEMBER AT ADJOINING PANEL EDGES AND BOUNDARIES ^e	LINES OF FASTENERS	BLOCKED DIAPHRAGMS					
						Cases 1 and 2 ^d					
						Fastener Spacing Per Line at Boundaries (inches)					
						4	2 ¹ / ₂	2			
						Fastener Spacing Per Line at Other Panel Edges (inches)					
						6	4	4	3	3	2
Structural I grades	10d common nails	1 ¹ / ₂	15 ¹ / ₃₂	3	2	605	815	875	1,150	—	—
				4	2	700	915	1,005	1,290	—	—
				4	3	875	1,220	1,285	1,395	—	—
			19 ¹ / ₃₂	3	2	670	880	965	1,255	—	—
				4	2	780	990	1,110	1,440	—	—
				4	3	965	1,320	1,405	1,790	—	—
	23 ¹ / ₃₂	3	2	730	955	1,050	1,365	—	—		
		4	2	855	1,070	1,210	1,565	—	—		
		4	3	1,050	1,430	1,525	1,800	—	—		
	14 gauge staples	2	15 ¹ / ₃₂	3	2	600	600	860	960	1,060	1,200
				4	3	860	900	1,160	1,295	1,295	1,400
				4	3	875	900	1,175	1,440	1,475	1,795
19 ¹ / ₃₂			3	2	600	600	875	960	1,075	1,200	
			4	3	875	900	1,175	1,440	1,475	1,795	
			4	3	875	900	1,175	1,440	1,475	1,795	
Sheathing single floor and other grades covered in DOC PS 1 and PS 2	10d common nails	1 ¹ / ₂	15 ¹ / ₃₂	3	2	525	725	765	1,010	—	—
				4	2	605	815	875	1,105	—	—
				4	3	765	1,085	1,130	1,195	—	—
			19 ¹ / ₃₂	3	2	650	860	935	1,225	—	—
				4	2	755	965	1,080	1,370	—	—
				4	3	935	1,290	1,365	1,485	—	—
	23 ¹ / ₃₂	3	2	710	935	1,020	1,335	—	—		
		4	2	825	1,050	1,175	1,445	—	—		
		4	3	1,020	1,400	1,480	1,565	—	—		
	14 gauge staples	2	15 ¹ / ₃₂	3	2	540	540	735	865	915	1,080
				4	3	735	810	1,005	1,105	1,105	1,195
				4	3	865	900	1,130	1,430	1,370	1,485
19 ¹ / ₃₂			3	2	600	600	865	960	1,065	1,200	
			4	3	865	900	1,130	1,430	1,370	1,485	
			4	3	865	900	1,130	1,490	1,430	1,545	

For SI: 1 inch = 25.4 mm, 1 pound per foot = 14.5939 N/m.

- For framing of other species: (1) Find specific gravity for species of framing lumber in AF&PA NDS. (2) For staples, find shear value from table above for Structural I panels (regardless of actual grade) and multiply value by 0.82 for species with specific gravity of 0.42 or greater, or 0.65 for all other species. (3) For nails, find shear value from table above for nail size of actual grade and multiply value by the following adjustment factor: Specific Gravity Adjustment Factor = [1 - (0.5 - SG)], where SG = Specific gravity of the framing lumber. This adjustment factor shall not be greater than 1.
- Fastening along intermediate framing members: Space fasteners a maximum of 12 inches on center, except 6 inches on center for spans greater than 32 inches.
- Panels conforming to PS 1 or PS 2.
- This table gives shear values for Cases 1 and 2 as shown in Table 2306.3.1. The values shown are applicable to Cases 3, 4, 5 and 6 as shown in Table 2306.3.1, providing fasteners at all continuous panel edges are spaced in accordance with the boundary fastener spacing.
- The minimum nominal depth of framing members shall be 3 inches nominal. The minimum nominal width of framing members not located at boundaries or adjoining panel edges shall be 2 inches.
- Staples shall have a minimum crown width of 7/16 inch, and shall be installed with their crowns parallel to the long dimension of the framing members.
- High load diaphragms shall be subject to special inspection in accordance with Section 1704.6.1.
- For shear loads of normal or permanent load duration as defined by the AF&PA NDS, the values in the table above shall be multiplied by 0.63 or 0.56, respectively.

2306.4.1 Wood structural panel shear walls. The allowable shear capacities for wood structural panel shear walls shall be in accordance with Table 2306.4.1. These capacities are permitted to be increased 40 percent for wind design. Shear walls are permitted to be calculated by principles of mechanics without limitations by using values for nail strength given in the AF&PA NDS and wood structural panel design properties given in the *APA Panel Design Specification*.

2306.4.2 Lumber sheathed shear walls. Single and double diagonally sheathed lumber diaphragms are permitted using the construction and allowable load provisions of Sections 2306.3.4 and 2306.3.5.

2306.4.3 Particleboard shear walls. The design shear capacity of particleboard shear walls shall be in accordance with Table 2306.4.3. Shear panels shall be constructed with particleboard sheets not less than 4 feet by 8 feet (1219 mm by 2438 mm), except at boundaries and changes in framing. Particleboard panels shall be designed to resist shear only, and chords, collector members and boundary elements shall be connected at all corners. Panel edges shall be backed with 2-inch (51 mm) nominal or wider framing. Sheets are permitted to be installed either horizontally or vertically. For $\frac{3}{8}$ -inch (9.5 mm) particleboard sheets installed with the long dimension parallel to the studs spaced 24 inches (610 mm) o.c., nails shall be spaced at 6 inches (152 mm) o.c. along intermediate framing members. For all other conditions, nails of the same size shall be spaced at 12 inches (305 mm) o.c. along intermediate framing members. Particleboard panels less than 12 inches (305 mm) wide shall be blocked. Particleboard shall not be used to resist seismic forces in structures in Seismic Design Category D, E or F.

2306.4.4 Fiberboard shear walls. The design shear capacity of fiberboard shear walls shall be in accordance with Table 2306.4.4. The fiberboard sheathing shall be applied vertically or horizontally to wood studs not less than 2 inch (51 mm) in nominal thickness spaced 16 inches (406 mm) o.c. Blocking not less than 2 inch (51 mm) nominal in thickness shall be provided at horizontal joints. Fiberboard shall not be used to resist seismic forces in structures in Seismic Design Category D, E or F.

2306.4.5 Shear walls sheathed with other materials. Shear capacities for walls sheathed with lath, plaster or gypsum board shall be in accordance with Table 2306.4.5. Shear walls sheathed with lath, plaster or gypsum board shall be constructed in accordance with Chapter 25 and Section 2306.4.5.1. Walls resisting seismic loads shall be subject to the limitations in Section 12.2.1 of ASCE 7.

2306.4.5.1 Application of gypsum board or lath and plaster to wood framing.

2306.4.5.1.1 Joint staggering. End joints of adjacent courses of gypsum board shall not occur over the same stud.

2306.4.5.1.2 Blocking. Where required in Table 2306.4.5, wood blocking having the same cross-sectional dimensions as the studs shall be provided at joints that are perpendicular to the studs.

2306.4.5.1.3 Fastening. Studs, top and bottom plates and blocking shall be fastened in accordance with Table 2304.9.1.

2306.4.5.1.4 Fasteners. The size and spacing of fasteners shall be set forth in Table 2306.4.5. Fasteners shall be spaced not less than $\frac{3}{8}$ inch (9.5 mm) from edges and ends of gypsum boards or sides of studs, blocking and top and bottom plates.

2306.4.5.1.5 Gypsum lath. Gypsum lath shall be applied perpendicular to the studs. Maximum allowable shear values shall be as set forth in Table 2306.4.5.

2306.4.5.1.6 Gypsum sheathing. Four-foot-wide (1219 mm) pieces of gypsum sheathing shall be applied parallel or perpendicular to studs. Two-foot-wide (610 mm) pieces of gypsum sheathing shall be applied perpendicular to the studs. Maximum allowable shear values shall be as set forth in Table 2306.4.5.

2306.4.5.1.7 Other gypsum boards. Gypsum board shall be applied parallel or perpendicular to studs. Maximum allowable shear values shall be as set forth in Table 2306.4.5.

SECTION 2307

LOAD AND RESISTANCE FACTOR DESIGN

2307.1 Load and resistance factor design. The structural analysis and construction of wood elements and structures using load and resistance factor design shall be in accordance with AF&PA NDS.

2307.1.1 Wood structural panel shear walls. In Seismic Design Category D, E or F, where shear design values exceed 490 pounds per foot (7154 N/m), all framing members receiving edge nailing from abutting panels shall not be less than a single 3-inch (76 mm) nominal member or two 2-inch (51 mm) nominal members fastened together in accordance with AF&PA NDS to transfer the design shear value between framing members. Wood structural panel joint and sill plate nailing shall be staggered in all cases. See Section 2305.3.11 for sill plate size and anchorage requirements.

SECTION 2308

CONVENTIONAL LIGHT-FRAME CONSTRUCTION

2308.1 General. The requirements of this section are intended for conventional light-frame construction. Other methods are permitted to be used, provided a satisfactory design is submitted showing compliance with other provisions of this code.

TABLE 2306.4.1
ALLOWABLE SHEAR (POUNDS PER FOOT) FOR WOOD STRUCTURAL PANEL SHEAR WALLS WITH
FRAMING OF DOUGLAS FIR-LARCH OR SOUTHERN PINE^a FOR WIND OR SEISMIC LOADING^{b, h, i, j}

PANEL GRADE	MINIMUM NOMINAL PANEL THICKNESS (inch)	MINIMUM FASTENER PENETRATION IN FRAMING (inches)	PANELS APPLIED DIRECT TO FRAMING						PANELS APPLIED OVER 1/2" OR 5/8" GYPSUM SHEATHING					
			NAIL (common or galvanized box) or staple size ^k			Fastener spacing at panel edges (inches)			NAIL (common or galvanized box) or staple size ^k			Fastener spacing at panel edges (inches)		
			6	4	3	6	4	3	6	4	3	6	4	3
Structural I Sheathing	5/16	1 1/4	6d (2 x 0.113" common, 2" x 0.099" galvanized box)	200	300	390	510	8d (2 1/2" x 0.131" common, 2 1/2" x 0.113" galvanized box)	200	300	390	510		
		1	1 1/2 16 Gauge	165	245	325	415	2 16 gauge	125	185	245	315		
	3/8	1 3/8	8d (2 1/2" x 0.131" common, 2 1/2" x 0.113" galvanized box)	230 ^d	360 ^d	460 ^d	610 ^d	10d (3" x 0.148" common, 3" x 0.128" galvanized box)	280	430	550 ^f	730		
		1	1 1/2 16 Gauge	155	235	315	400	2 16 gauge	155	235	310	400		
	7/16	1 3/8	8d (2 1/2" x 0.131" common, 2 1/2" x 0.113" galvanized box)	255 ^d	395 ^d	505 ^d	670 ^d	10d (3" x 0.148" common, 3" x 0.128" galvanized box)	280	430	550 ^f	730		
		1	1 1/2 16 Gauge	170	260	345	440	2 16 gauge	155	235	310	400		
	15/32	1 3/8	8d (2 1/2" x 0.131" common, 2 1/2" x 0.113" galvanized box)	280	430	550	730	10d (3" x 0.148" common, 3" x 0.128" galvanized box)	280	430	550 ^f	730		
		1	1 1/2 16 Gauge	185	280	375	475	2 16 gauge	155	235	300	400		
	Sheathing, plywood siding ^e except Group 5 Species	5/16 or 1/4	1 1/2	10d (3" x 0.148" common, 3" x 0.128" galvanized box)	340	510	665 ^f	870	10d (3" x 0.148" common, 3" x 0.128" galvanized box)	—	—	—	—	
			1 1/4	6d (2" x 0.113" common, 2" x 0.099" galvanized box)	180	270	350	450	8d (2 1/2" x 0.131" common, 2 1/2" x 0.113" galvanized box)	180	270	350	450	
		3/8	1	1 1/2 16 gauge	145	220	295	375	2 16 gauge	110	165	220	285	
			1 1/4	6d (2" x 0.113" common, 2" x 0.099" galvanized box)	200	300	390	510	8d (2 1/2" x 0.131" common, 2 1/2" x 0.113" galvanized box)	200	300	390	510	
7/16		1 3/8	8d (2 1/2" x 0.131" common, 2 1/2" x 0.113" galvanized box)	220 ^d	320 ^d	410 ^d	530 ^d	10d (3" x 0.148" common, 3" x 0.128" galvanized box)	260	380	490 ^f	640		
		1	1 1/2 16 Gauge	140	210	280	360	2 16 gauge	140	210	280	360		
15/32		1 3/8	8d (2 1/2" x 0.131" common, 2 1/2" x 0.113" galvanized box)	240 ^d	350 ^d	450 ^d	585 ^d	10d (3" x 0.148" common, 3" x 0.128" galvanized box)	260	380	490 ^f	640		
		1	1 1/2 16 Gauge	155	230	310	395	2 16 gauge	140	210	280	360		
19/32		1 1/2	10d (3" x 0.148" common, 3" x 0.128" galvanized box)	310	460	600 ^f	770	10d (3" x 0.148" common, 3" x 0.128" galvanized box)	260	380	490 ^f	640		
		1	1 1/2 16 Gauge	170	255	335	430	2 16 gauge	140	210	280	360		
5/16 ^c		3/8	1 1/4	10d (3" x 0.148" common, 3" x 0.128" galvanized box)	340	510	665 ^f	870	10d (3" x 0.148" common, 3" x 0.128" galvanized box)	—	—	—	—	
			1	1 3/4 16 Gauge	185	280	375	475	—	—	—	—		
	Nail Size (galvanized casing)			Nail Size (galvanized casing)			Nail Size (galvanized casing)			Nail Size (galvanized casing)				
3/8	3/8	1 1/4	6d (2" x 0.099")	140	210	275	360	8d (2 1/2" x 0.113")	140	210	275	360		
		1 3/8	8d (2 1/2" x 0.113")	160	240	310	410	10d (3" x 0.128")	160	240	310 ^f	410		

(continued)

Notes to Table 2306.4.1

For SI: 1 inch = 25.4 mm, 1 pound per foot = 14.5939 N/m.

- a. For framing of other species: (1) Find specific gravity for species of lumber in AF&PA NDS. (2) For staples find shear value from table above for Structural I panels (regardless of actual grade) and multiply value by 0.82 for species with specific gravity of 0.42 or greater, or 0.65 for all other species. (3) For nails find shear value from table above for nail size for actual grade and multiply value by the following adjustment factor: Specific Gravity Adjustment Factor = [1-(0.5 - SG)], where SG = Specific Gravity of the framing lumber. This adjustment factor shall not be greater than 1.
- b. Panel edges backed with 2-inch nominal or wider framing. Install panels either horizontally or vertically. Space fasteners maximum 6 inches on center along intermediate framing members for 3/8-inch and 7/16-inch panels installed on studs spaced 24 inches on center. For other conditions and panel thickness, space fasteners maximum 12 inches on center on intermediate supports.
- c. 3/8-inch panel thickness or siding with a span rating of 16 inches on center is the minimum recommended where applied direct to framing as exterior siding.
- d. Allowable shear values are permitted to be increased to values shown for 15/32-inch sheathing with same nailing provided (a) studs are spaced a maximum of 16 inches on center, or (b) panels are applied with long dimension across studs.
- e. Framing at adjoining panel edges shall be 3 inches nominal or wider, and nails shall be staggered where nails are spaced 2 inches on center.
- f. Framing at adjoining panel edges shall be 3 inches nominal or wider, and nails shall be staggered where both of the following conditions are met: (1) 10d (3" x 0.148") nails having penetration into framing of more than 1 1/2 inches and (2) nails are spaced 3 inches on center.
- g. Values apply to all-veneer plywood. Thickness at point of fastening on panel edges governs shear values.
- h. Where panels applied on both faces of a wall and nail spacing is less than 6 inches o.c. on either side, panel joints shall be offset to fall on different framing members, or framing shall be 3-inch nominal or thicker at adjoining panel edges and nails on each side shall be staggered.
- i. In Seismic Design Category D, E or F, where shear design values exceed 350 pounds per linear foot, all framing members receiving edge nailing from abutting panels shall not be less than a single 3-inch nominal member, or two 2-inch nominal members fastened together in accordance with Section 2306.1 to transfer the design shear value between framing members. Wood structural panel joint and sill plate nailing shall be staggered in all cases. See Section 2305.3.11 for sill plate size and anchorage requirements.
- j. Galvanized nails shall be hot dipped or tumbled.
- k. Staples shall have a minimum crown width of 7/16 inch and shall be installed with their crowns parallel to the long dimension of the framing members.
- l. For shear loads of normal or permanent load duration as defined by the AF&PA NDS, the values in the table above shall be multiplied by 0.63 or 0.56, respectively.

**TABLE 2306.4.3
ALLOWABLE SHEAR FOR PARTICLEBOARD SHEAR WALL SHEATHING^b**

PANEL GRADE	MINIMUM NOMINAL PANEL THICKNESS (inch)	MINIMUM NAIL PENETRATION IN FRAMING (inches)	PANELS APPLIED DIRECT TO FRAMING				
			Nail size (common or galvanized box)	Allowable shear (pounds per foot) nail spacing at panel edges (inches) ^a			
				6	4	3	2
M-S "Exterior Glue" and —2 "Exterior Glue"	3/8	1 1/2	6d	120	180	230	300
	3/8	1 1/2	8d	130	190	240	315
	1/2			140	210	270	350
	1/2	1 5/8	10d	185	275	360	460
	5/8			200	305	395	520

For SI: 1 inch = 25.4 mm, 1 pound per foot = 14.5939 N/m.

- a. Values are not permitted in Seismic Design Category D, E or F.
- b. Galvanized nails shall be hot-dipped or tumbled.

**TABLE 2306.4.4
ALLOWABLE SHEAR VALUES (plf) FOR WIND OR SEISMIC LOADING ON SHEAR WALLS OF FIBERBOARD SHEATHING BOARD CONSTRUCTION FOR TYPE V CONSTRUCTION ONLY^{a,b,c,d,e,f,g,h}**

THICKNESS AND GRADE	FASTENER SIZE	SHEAR VALUE (pounds per linear foot) 3-INCH NAIL SPACING AROUND PERIMETER AND 6-INCH AT INTERMEDIATE POINTS
1/2" Structural	No. 11 gauge galvanized roofing nail 1 1/2" long, 7/16" head	125 ^g
25/32" Structural	No. 11 gauge galvanized roofing nail 1 3/4" long, 7/16" head	175 ^g

For SI: 1 inch = 25.4 mm, 1 pound per foot = 14.5939 N/m.

- a. Fiberboard sheathing diaphragms shall not be used to brace concrete or masonry walls.
- b. Panel edges shall be backed with 2 inch or wider framing of Douglas fir-larch or Southern pine.
- c. Fiberboard sheathing on one side only.
- d. Fiberboard panels are installed with their long dimension parallel or perpendicular to studs.
- e. Fasteners shall be spaced 6 inches on center along intermediate framing members.
- f. For framing of other species: (1) Find specific gravity for species of lumber in AF&PA NDS and (2) Multiply the shear value from the above table by 0.82 for species with specific gravity of 0.42 or greater, or 0.65 for all other species.
- g. The same values can be applied when staples are used as described in Table 2304.9.1.
- h. Values are not permitted in Seismic Design Category D, E or F.

**TABLE 2306.4.5
ALLOWABLE SHEAR FOR WIND OR SEISMIC FORCES FOR SHEAR WALLS OF LATH
AND PLASTER OR GYPSUM BOARD WOOD FRAMED WALL ASSEMBLIES**

TYPE OF MATERIAL	THICKNESS OF MATERIAL	WALL CONSTRUCTION	FASTENER SPACING ^b MAXIMUM (inches)	SHEAR VALUE ^{a,e} (plf)	MINIMUM FASTENER SIZE ^{c,d,j,k}	
1. Expanded metal or woven wire lath and portland cement plaster	$\frac{7}{8}$ "	Unblocked	6	180	No. 11 gauge $1\frac{1}{2}$ " long, $\frac{7}{16}$ " head 16 Ga. Galv. Staple, $\frac{7}{8}$ " legs	
2. Gypsum lath, plain or perforated	$\frac{3}{8}$ " lath and $\frac{1}{2}$ " plaster	Unblocked	5	100	No. 13 gauge, $1\frac{1}{8}$ " long, $\frac{19}{64}$ " head, plasterboard nail 16 Ga. Galv. Staple, $1\frac{1}{8}$ " long 0.120" Nail, min. $\frac{3}{8}$ " head, $1\frac{1}{4}$ " long	
3. Gypsum sheathing	$\frac{1}{2}$ " \times 2' \times 8'	Unblocked	4	75	No. 11 gauge, $1\frac{3}{4}$ " long, $\frac{7}{16}$ " head, diamond-point, galvanized	
	$\frac{1}{2}$ " \times 4'	Blocked ^f Unblocked	4 7	175 100	16 Ga. Galv. Staple, $1\frac{3}{4}$ " long	
	$\frac{5}{8}$ " \times 4'	Blocked	4" edge/ 7" field	200	6d galvanized 0.120" Nail, min. $\frac{3}{8}$ " head, $1\frac{3}{4}$ " long	
4. Gypsum board, gypsum veneer base or water-resistant gypsum backing board	$\frac{1}{2}$ "	Unblocked ^f	7	75	5d cooler ($1\frac{5}{8}$ " \times .086") or wallboard 0.120" nail, min. $\frac{3}{8}$ " head, $1\frac{1}{2}$ " long 16 gauge Staple, $1\frac{1}{2}$ " long	
		Unblocked ^f	4	110		
		Unblocked	7	100		
		Unblocked	4	125		
		Blocked ^g	7	125		
		Blocked ^g	4	150		
		Unblocked	8/12 ^h	60		No. 6 $1\frac{1}{4}$ " screws ⁱ
		Blocked ^g	4/16 ^h	160		
		Blocked ^g	4/12 ^h	155		
	Blocked ^{f, g}	8/12 ^h	70			
	$\frac{5}{8}$ "	Unblocked ^f		7	115	6d cooler ($1\frac{7}{8}$ " \times 0.092") or wallboard 0.120" Nail, min. $\frac{3}{8}$ " head, $1\frac{3}{4}$ " long 16 gauge Staple, $1\frac{1}{2}$ " legs, $1\frac{5}{8}$ " long
				4	145	
		Blocked ^g		7	145	
			4	175		
Blocked ^g Two-ply		Base ply: 9 Face ply: 7	250	Base ply-6d cooler ($1\frac{7}{8}$ " \times 0.092") or wallboard $1\frac{3}{4}$ " \times 0.120" Nail, min. $\frac{3}{8}$ " head $1\frac{3}{8}$ " 16 Ga. Galv. Staple $1\frac{3}{8}$ " 16 gauge Galv. Staple Face ply-8d cooler ($2\frac{3}{8}$ " \times 0.113") or wallboard 0.120" Nail, min. $\frac{3}{8}$ " head, $2\frac{3}{8}$ " long 15 Ga. Galv. Staple, $2\frac{1}{4}$ " long		
Unblocked	8/12 ^h	70	No. 6- $1\frac{1}{4}$ " screws ⁱ			
Blocked ^g	8/12 ^h	90				

For SI: 1 inch = 25.4 mm, 1 foot = 304.8 mm, 1 pound per foot = 14.5939 N/m.

- These shear walls shall not be used to resist loads imposed by masonry or concrete construction (see Section 2305.1.5). Values shown are for short-term loading due to wind or seismic loading. Walls resisting seismic loads shall be subject to the limitations in Section 12.2.1 of ASCE 7. Values shown shall be reduced 25 percent for normal loading.
- Applies to fastening at studs, top and bottom plates and blocking.
- Alternate fasteners are permitted to be used if their dimensions are not less than the specified dimensions. Drywall screws are permitted to substitute for the 5d ($1\frac{5}{8}$ " \times 0.086"), and 6d ($1\frac{7}{8}$ " \times 0.092") (cooler) nails listed above, and No. 6 $1\frac{1}{4}$ " inch Type S or W screws for 6d ($1\frac{7}{8}$ " \times 0.092") (cooler) nails.
- For properties of cooler nails, see ASTM C 514.
- Except as noted, shear values are based on a maximum framing spacing of 16 inches on center.
- Maximum framing spacing of 24 inches on center.
- All edges are blocked, and edge fastening is provided at all supports and all panel edges.
- First number denotes fastener spacing at the edges; second number denotes fastener spacing at intermediate framing members.
- Screws are Type W or S.
- Staples shall have a minimum crown width of $\frac{7}{16}$ " inch, measured outside the legs, and shall be installed with their crowns parallel to the long dimension of the framing members.
- Staples for the attachment of gypsum lath and woven-wire lath shall have a minimum crown width of $\frac{7}{16}$ " inch, measured outside the legs.

Interior nonload-bearing partitions, ceilings and curtain walls of conventional light-frame construction are not subject to the limitations of this section. Alternatively, compliance with AF&PA WFCM shall be permitted subject to the limitations therein and the limitations of this code. Detached one- and two-family dwellings and multiple single-family dwellings (townhouses) not more than three stories above grade plane in height with a separate means of egress and their accessory structures shall comply with the *International Residential Code*.

2308.1.1 Portions exceeding limitations of conventional construction. When portions of a building of otherwise conventional construction exceed the limits of Section 2308.2, these portions and the supporting load path shall be designed in accordance with accepted engineering practice and the provisions of this code. For the purposes of this section, the term “portions” shall mean parts of buildings containing volume and area such as a room or a series of rooms.

2308.2 Limitations. Buildings are permitted to be constructed in accordance with the provisions of conventional light-frame construction, subject to the following limitations, and to further limitations of Sections 2308.11 and 2308.12.

1. Buildings shall be limited to a maximum of three stories above grade plane. For the purposes of this section, for buildings in Seismic Design Category D or E as determined in Section 1613, cripple stud walls shall be considered to be a story.

Exception: Solid blocked cripple walls not exceeding 14 inches (356 mm) in height need not be considered a story.

2. Bearing wall floor-to-floor heights shall not exceed a stud height of 10 feet (3048 mm) plus a height of floor framing not to exceed 16 inches (406 mm).
3. Loads as determined in Chapter 16 shall not exceed the following:
 - 3.1. Average dead loads shall not exceed 15 psf (718 N/m²) for combined roof and ceiling, exterior walls, floors and partitions.

Exceptions:

1. Subject to the limitations of Sections 2308.11.2 and 2308.12.2, stone or masonry veneer up to the lesser of 5 inches (127 mm) thick or 50 psf (2395 N/m²) and installed in accordance with Chapter 14 is permitted to a height of 30 feet (9144 mm) above a noncombustible foundation, with an additional 8 feet (2438 mm) permitted for gable ends.
2. Concrete or masonry fireplaces, heaters and chimneys shall be permitted in accordance with the provisions of this code.
- 3.2. Live loads shall not exceed 40 psf (1916 N/m²) for floors.
- 3.3. Ground snow loads shall not exceed 50 psf (2395 N/m²).

4. Wind speeds shall not exceed 100 miles per hour (mph) (44 m/s) (3-second gust).

Exception: Wind speeds shall not exceed 110 mph (48.4 m/s) (3-second gust) for buildings in Exposure Category B.

5. Roof trusses and rafters shall not span more than 40 feet (12 192 mm) between points of vertical support.
6. The use of the provisions for conventional light-frame construction in this section shall not be permitted for Occupancy Category IV buildings assigned to Seismic Design Category B, C, D, E or F, as determined in Section 1613.
7. Conventional light-frame construction is limited in irregular structures in Seismic Design Category D or E, as specified in Section 2308.12.6.

2308.2.1 Basic wind speed greater than 100 mph (3-second gust). Where the basic wind speed exceeds 100 mph (3-second gust), the provisions of either AF&PA WFCM, or the SBCCI SSTD 10 are permitted to be used.

2308.2.2 Buildings in Seismic Design Category B, C, D or E. Buildings of conventional light-frame construction in Seismic Design Category B or C, as determined in Section 1613, shall comply with the additional requirements in Section 2308.11.

Buildings of conventional light-frame construction in Seismic Design Category D or E, as determined in Section 1613, shall comply with the additional requirements in Section 2308.12.

2308.3 Braced wall lines. Buildings shall be provided with exterior and interior braced wall lines as described in Section 2308.9.3 and installed in accordance with Sections 2308.3.1 through 2308.3.4.

2308.3.1 Spacing. Spacing of braced wall lines shall not exceed 35 feet (10 668 mm) o.c. in both the longitudinal and transverse directions in each story.

2308.3.2 Braced wall panel connections. Forces shall be transferred from the roofs and floors to braced wall panels and from the braced wall panels in upper stories to the braced wall panels in the story below by the following:

1. Braced wall panel top and bottom plates shall be fastened to joists, rafters or full-depth blocking. Braced wall panels shall be extended and fastened to roof framing at intervals not to exceed 50 feet (15 240 mm) between parallel braced wall lines.

Exception: Where roof trusses are used, lateral forces shall be transferred from the roof diaphragm to the braced wall by blocking of the ends of the trusses or by other approved methods.

2. Bottom plate fastening to joist or blocking below shall be with not less than 3-16d nails at 16 inches (406 mm) o.c.
3. Blocking shall be nailed to the top plate below with not less than 3-8d toenails per block.

4. Joists parallel to the top plates shall be nailed to the top plate with not less than 8d toenails at 6 inches (152 mm) o.c.

In addition, top plate laps shall be nailed with not less than 8-16d face nails on each side of each break in the top plate.

2308.3.3 Sill anchorage. Where foundations are required by Section 2308.3.4, braced wall line sills shall be anchored to concrete or masonry foundations. Such anchorage shall conform to the requirements of Section 2308.6 except that such anchors shall be spaced at not more than 4 feet (1219 mm) o.c. for structures over two stories in height. The anchors shall be distributed along the length of the braced wall line. Other anchorage devices having equivalent capacity are permitted.

2308.3.3.1 Anchorage to all-wood foundations.

Where all-wood foundations are used, the force transfer from the braced wall lines shall be determined based on calculation and shall have a capacity greater than or equal to the connections required by Section 2308.3.3.

2308.3.4 Braced wall line support. Braced wall lines shall be supported by continuous foundations.

Exception: For structures with a maximum plan dimension not over 50 feet (15 240 mm), continuous foundations are required at exterior walls only.

2308.4 Design of elements. Combining of engineered elements or systems and conventionally specified elements or systems is permitted subject to the following limits:

2308.4.1 Elements exceeding limitations of conventional construction. When a building of otherwise conventional construction contains structural elements exceeding the limits of Section 2308.2, these elements and the supporting load path shall be designed in accordance with accepted engineering practice and the provisions of this code.

2308.4.2 Structural elements or systems not described herein. When a building of otherwise conventional construction contains structural elements or systems not described in Section 2308, these elements or systems shall be designed in accordance with accepted engineering practice and the provisions of this code. The extent of such design need only demonstrate compliance of the nonconventional elements with other applicable provisions of this code and shall be compatible with the performance of the conventionally framed system.

2308.5 Connections and fasteners. Connections and fasteners used in conventional construction shall comply with the requirements of Section 2304.9.

2308.6 Foundation plates or sills. Foundations and footings shall be as specified in Chapter 18. Foundation plates or sills resting on concrete or masonry foundations shall comply with Section 2304.3.1. Foundation plates or sills shall be bolted or anchored to the foundation with not less than 1/2-inch-diameter (12.7 mm) steel bolts or approved anchors. Bolts shall be

embedded at least 7 inches (178 mm) into concrete or masonry, and spaced not more than 6 feet (1829 mm) apart. There shall be a minimum of two bolts or anchor straps per piece with one bolt or anchor strap located not more than 12 inches (305 mm) or less than 4 inches (102 mm) from each end of each piece. A properly sized nut and washer shall be tightened on each bolt to the plate.

2308.7 Girders. Girders for single-story construction or girders supporting loads from a single floor shall not be less than 4 inches by 6 inches (102 mm by 152 mm) for spans 6 feet (1829 mm) or less, provided that girders are spaced not more than 8 feet (2438 mm) o.c. Spans for built-up 2-inch (51 mm) girders shall be in accordance with Table 2308.9.5 or 2308.9.6. Other girders shall be designed to support the loads specified in this code. Girder end joints shall occur over supports.

Where a girder is spliced over a support, an adequate tie shall be provided. The ends of beams or girders supported on masonry or concrete shall not have less than 3 inches (76 mm) of bearing.

2308.8 Floor joists. Spans for floor joists shall be in accordance with Table 2308.8(1) or 2308.8(2). For other grades and or species, refer to the *AF&PA Span Tables for Joists and Rafters*.

2308.8.1 Bearing. Except where supported on a 1-inch by 4-inch (25.4 mm by 102 mm) ribbon strip and nailed to the adjoining stud, the ends of each joist shall not have less than 1 1/2 inches (38 mm) of bearing on wood or metal, or less than 3 inches (76 mm) on masonry.

2308.8.2 Framing details. Joists shall be supported laterally at the ends and at each support by solid blocking except where the ends of the joists are nailed to a header, band or rim joist or to an adjoining stud or by other means. Solid blocking shall not be less than 2 inches (51 mm) in thickness and the full depth of the joist. Notches on the ends of joists shall not exceed one-fourth the joist depth. Holes bored in joists shall not be within 2 inches (51 mm) of the top or bottom of the joist, and the diameter of any such hole shall not exceed one-third the depth of the joist. Notches in the top or bottom of joists shall not exceed one-sixth the depth and shall not be located in the middle third of the span.

Joist framing from opposite sides of a beam, girder or partition shall be lapped at least 3 inches (76 mm) or the opposing joists shall be tied together in an approved manner.

Joists framing into the side of a wood girder shall be supported by framing anchors or on ledger strips not less than 2 inches by 2 inches (51 mm by 51 mm).

2308.8.2.1 Engineered wood products. Cuts, notches and holes bored in trusses, structural composite lumber, structural glue-laminated members or I-joists are not permitted except where permitted by the manufacturer's recommendations or where the effects of such alterations are specifically considered in the design of the member by a registered design professional.

TABLE 2308.8(1)
FLOOR JOIST SPANS FOR COMMON LUMBER SPECIES
(Residential Sleeping Areas, Live Load = 30 psf, L/Δ = 360)

JOIST SPACING (Inches)	DEAD LOAD = 10 psf						DEAD LOAD = 20 psf						
	2x6	2x8	2x10	2x12	2x6	2x12	2x8	2x10	2x12	2x6	2x8	2x10	2x12
	Maximum floor joist spans (ft. - in.)												
SPECIES AND GRADE	(ft. - in.)	(ft. - in.)	(ft. - in.)	(ft. - in.)	(ft. - in.)	(ft. - in.)	(ft. - in.)	(ft. - in.)	(ft. - in.)	(ft. - in.)	(ft. - in.)	(ft. - in.)	(ft. - in.)
12	Douglas Fir-Larch SS	12-6	16-6	21-0	25-7	12-6	16-6	21-0	25-7	12-6	16-6	21-0	25-7
	Douglas Fir-Larch #1	12-0	15-10	20-3	24-8	12-0	15-7	19-0	24-0	12-0	15-7	19-0	22-0
	Douglas Fir-Larch #2	11-10	15-7	19-10	23-0	11-6	14-7	17-9	20-7	11-6	14-7	17-9	20-7
	Douglas Fir-Larch #3	9-8	12-4	15-0	17-5	8-8	11-0	13-5	15-7	8-8	11-0	13-5	15-7
	Hem-Fir SS	11-10	15-7	19-10	24-2	11-10	15-7	19-10	24-2	11-10	15-7	19-10	24-2
	Hem-Fir #1	11-7	15-3	19-5	23-7	11-7	15-2	18-6	21-6	11-7	15-2	18-6	21-6
	Hem-Fir #2	11-0	14-6	18-6	22-6	11-0	14-4	17-6	20-4	11-0	14-4	17-6	20-4
	Hem-Fir #3	9-8	12-4	15-0	17-5	8-8	11-0	13-5	15-7	8-8	11-0	13-5	15-7
	Southern Pine SS	12-3	16-2	20-8	25-1	12-3	16-2	20-8	25-1	12-3	16-2	20-8	25-1
	Southern Pine #1	12-0	15-10	20-3	24-8	12-0	15-10	20-3	24-8	12-0	15-10	20-3	24-8
	Southern Pine #2	11-10	15-7	19-10	24-2	11-10	15-7	19-10	24-2	11-10	15-7	19-10	24-2
	Southern Pine #3	10-5	13-3	15-8	18-8	9-4	11-11	14-0	16-8	9-4	11-11	14-0	16-8
16	Spruce-Pine-Fir SS	11-7	15-3	19-5	23-7	11-7	15-3	19-5	23-7	11-7	15-3	19-5	23-7
	Spruce-Pine-Fir #1	11-3	14-11	19-0	23-0	11-3	14-7	17-9	20-7	11-3	14-7	17-9	20-7
	Spruce-Pine-Fir #2	11-3	14-11	19-0	23-0	11-3	14-7	17-9	20-7	11-3	14-7	17-9	20-7
	Spruce-Pine-Fir #3	9-8	12-4	15-0	17-5	8-8	11-0	13-5	15-7	8-8	11-0	13-5	15-7
	Douglas Fir-Larch SS	11-4	15-0	19-1	23-3	11-4	15-0	19-1	23-0	11-4	15-0	19-1	23-0
	Douglas Fir-Larch #1	10-11	14-5	18-5	21-4	10-8	13-6	16-5	19-1	10-8	13-6	16-5	19-1
	Douglas Fir-Larch #2	10-9	14-1	17-2	19-11	9-11	12-7	15-5	17-10	9-11	12-7	15-5	17-10
	Douglas Fir-Larch #3	8-5	10-8	13-0	15-1	7-6	9-6	11-8	13-6	7-6	9-6	11-8	13-6
	Hem-Fir SS	10-9	14-2	18-0	21-11	10-9	14-2	18-0	21-11	10-9	14-2	18-0	21-11
	Hem-Fir #1	10-6	13-10	17-8	20-9	10-4	13-1	16-0	18-7	10-4	13-1	16-0	18-7
	Hem-Fir #2	10-0	13-2	16-10	19-8	9-10	12-5	15-2	17-7	9-10	12-5	15-2	17-7
	Hem-Fir #3	8-5	10-8	13-0	15-1	7-6	9-6	11-8	13-6	7-6	9-6	11-8	13-6
16	Southern Pine SS	11-2	14-8	18-9	22-10	11-2	14-8	18-9	22-10	11-2	14-8	18-9	22-10
	Southern Pine #1	10-11	14-5	18-5	22-5	10-11	14-5	17-11	21-4	10-11	14-5	17-11	21-4
	Southern Pine #2	10-9	14-2	18-0	21-1	10-5	13-6	16-1	18-10	10-5	13-6	16-1	18-10
	Southern Pine #3	9-0	11-6	13-7	16-2	8-1	10-3	12-2	14-6	8-1	10-3	12-2	14-6
	Spruce-Pine-Fir SS	10-6	13-10	17-8	21-6	10-6	13-10	17-8	21-4	10-6	13-10	17-8	21-4
	Spruce-Pine-Fir #1	10-3	13-6	17-2	19-11	9-11	12-7	15-5	17-10	9-11	12-7	15-5	17-10
	Spruce-Pine-Fir #2	10-3	13-6	17-2	19-11	9-11	12-7	15-5	17-10	9-11	12-7	15-5	17-10
	Spruce-Pine-Fir #3	8-5	10-8	13-0	15-1	7-6	9-6	11-8	13-6	7-6	9-6	11-8	13-6

(continued)

TABLE 2308.8(1)—continued
 FLOOR JOIST SPANS FOR COMMON LUMBER SPECIES
 (Residential Sleeping Areas, Live Load = 30 psf, L/Δ = 360)

JOIST SPACING (inches)	DEAD LOAD = 10 psf				DEAD LOAD = 20 psf				
	2x6	2x8	2x10	2x12	2x6	2x8	2x10	2x12	
	Maximum floor joist spans (ft. - in.)								
SPECIES AND GRADE	(ft. - in.)	(ft. - in.)	(ft. - in.)	(ft. - in.)	(ft. - in.)	(ft. - in.)	(ft. - in.)	(ft. - in.)	
19.2	Douglas Fir-Larch SS	10-8	14-1	18-0	21-10	10-8	14-1	18-0	21-0
	Douglas Fir-Larch #1	10-4	13-7	16-9	19-6	9-8	12-4	15-0	17-5
	Douglas Fir-Larch #2	10-1	12-10	15-8	18-3	9-1	11-6	14-1	16-3
	Douglas Fir-Larch #3	7-8	9-9	11-10	13-9	6-10	8-8	10-7	12-4
	Hem-Fir SS	10-1	13-4	17-0	20-8	10-1	13-4	17-0	20-7
	Hem-Fir #1	9-10	13-0	16-4	19-0	9-6	12-0	14-8	17-0
	Hem-Fir #2	9-5	12-5	15-6	17-1	8-11	11-4	13-10	16-1
	Hem-Fir #3	7-8	9-9	11-10	13-9	6-10	8-8	10-7	12-4
	Southern Pine SS	10-6	13-10	17-8	21-6	10-6	13-10	17-8	21-6
	Southern Pine #1	10-4	13-7	17-4	21-1	10-4	13-7	16-4	19-6
	Southern Pine #2	10-1	13-4	16-5	19-3	9-6	12-4	14-8	17-2
	Southern Pine #3	8-3	10-6	12-5	14-9	7-4	9-5	11-1	13-2
24	Spruce-Pine-Fir SS	9-10	13-0	16-7	20-2	9-10	13-0	16-7	19-6
	Spruce-Pine-Fir #1	9-8	12-9	15-8	18-3	9-1	11-6	14-1	16-3
	Spruce-Pine-Fir #2	9-8	12-9	15-8	18-3	9-1	11-6	14-1	16-3
	Spruce-Pine-Fir #3	7-8	9-9	11-10	13-9	6-10	8-8	10-7	12-4
	Douglas Fir-Larch SS	9-11	13-1	16-8	20-3	9-11	13-1	16-2	18-9
	Douglas Fir-Larch #1	9-7	12-4	15-0	17-5	8-8	11-0	13-5	15-7
	Douglas Fir-Larch #2	9-1	11-6	14-1	16-3	8-1	10-3	12-7	14-7
	Douglas Fir-Larch #3	6-10	8-8	10-7	12-4	6-2	7-9	9-6	11-0
	Hem-Fir SS	9-4	12-4	15-9	19-2	9-4	12-4	15-9	18-5
	Hem-Fir #1	9-2	12-0	14-8	17-0	8-6	10-9	13-1	15-2
	Hem-Fir #2	8-9	11-4	13-10	16-1	8-0	10-2	12-5	14-4
	Hem-Fir #3	6-10	8-8	10-7	12-4	6-2	7-9	9-6	11-0
24	Southern Pine SS	9-9	12-10	16-5	19-11	9-9	12-10	16-5	19-11
	Southern Pine #1	9-7	12-7	16-1	19-6	9-7	12-4	14-7	17-5
	Southern Pine #2	9-4	12-4	14-8	17-2	8-6	11-0	13-1	15-5
	Southern Pine #3	7-4	9-5	11-1	13-2	6-7	8-5	9-11	11-10
	Spruce-Pine-Fir SS	9-2	12-1	15-5	18-9	9-2	12-1	15-0	17-5
	Spruce-Pine-Fir #1	8-11	11-6	14-1	16-3	8-1	10-3	12-7	14-7
	Spruce-Pine-Fir #2	8-11	11-6	14-1	16-3	8-1	10-3	12-7	14-7
	Spruce-Pine-Fir #3	6-10	8-8	10-7	12-4	6-2	7-9	9-6	11-0

Check sources for availability of lumber in lengths greater than 20 feet.
 For SI: 1 inch = 25.4 mm, 1 foot = 304.8 mm, 1 pound per square foot = 47.8 N/m².

TABLE 2308.8(2)
 FLOOR JOIST SPANS FOR COMMON LUMBER SPECIES
 (Residential Living Areas, Live Load = 40 psf, L/Δ = 360)

JOIST SPACING (Inches)	DEAD LOAD = 10 psf					DEAD LOAD = 20 psf					
	2x6	2x8	2x10	2x12	2x6	2x8	2x10	2x12	2x10	2x12	
	Maximum floor joist spans (ft. - in.)										
SPECIES AND GRADE											
12	Douglas Fir-Larch	11-4	15-0	19-1	23-3	11-4	15-0	19-1	23-3	19-1	23-3
	Douglas Fir-Larch	10-11	14-5	18-5	22-0	10-11	14-2	17-4	20-1	17-4	20-1
	Douglas Fir-Larch	10-9	14-2	17-9	20-7	10-6	13-3	16-3	18-10	16-3	18-10
	Douglas Fir-Larch	8-8	11-0	13-5	15-7	7-11	10-0	12-3	14-3	12-3	14-3
	Hem-Fir	10-9	14-2	18-0	21-11	10-9	14-2	18-0	21-11	18-0	21-11
	Hem-Fir	10-6	13-10	17-8	21-6	10-6	13-10	16-11	19-7	16-11	19-7
	Hem-Fir	10-0	13-2	16-10	20-4	10-0	13-1	16-0	18-6	16-0	18-6
	Hem-Fir	8-8	11-0	13-5	15-7	7-11	10-0	12-3	14-3	12-3	14-3
	Southern Pine	11-2	14-8	18-9	22-10	11-2	14-8	18-9	22-10	18-9	22-10
	Southern Pine	10-11	14-5	18-5	22-5	10-11	14-5	18-5	22-5	18-5	22-5
	Southern Pine	10-9	14-2	18-0	21-9	10-9	14-2	16-11	19-10	16-11	19-10
	Southern Pine	9-4	11-11	14-0	16-8	8-6	10-10	12-10	15-3	12-10	15-3
16	Spruce-Pine-Fir	10-6	13-10	17-8	21-6	10-6	13-10	17-8	21-6	17-8	21-6
	Spruce-Pine-Fir	10-3	13-6	17-3	20-7	10-3	13-3	16-3	18-10	16-3	18-10
	Spruce-Pine-Fir	10-3	13-6	17-3	20-7	10-3	13-3	16-3	18-10	16-3	18-10
	Spruce-Pine-Fir	8-8	11-0	13-5	15-7	7-11	10-0	12-3	14-3	12-3	14-3
	Douglas Fir-Larch	10-4	13-7	17-4	21-1	10-4	13-7	17-4	21-0	17-4	21-0
	Douglas Fir-Larch	9-11	13-1	16-5	19-1	9-8	12-4	15-0	17-5	15-0	17-5
	Douglas Fir-Larch	9-9	12-7	15-5	17-10	9-1	11-6	14-1	16-3	14-1	16-3
	Douglas Fir-Larch	7-6	9-6	11-8	13-6	6-10	8-8	10-7	12-4	10-7	12-4
	Hem-Fir	9-9	12-10	16-5	19-11	9-9	12-10	16-5	19-11	16-5	19-11
	Hem-Fir	9-6	12-7	16-0	18-7	9-6	12-0	14-8	17-0	14-8	17-0
	Hem-Fir	9-1	12-0	15-2	17-7	8-11	11-4	13-10	16-1	13-10	16-1
	Hem-Fir	7-6	9-6	11-8	13-6	6-10	8-8	10-7	12-4	10-7	12-4
16	Southern Pine	10-2	13-4	17-0	20-9	10-2	13-4	17-0	20-9	17-0	20-9
	Southern Pine	9-11	13-1	16-9	20-4	9-11	13-1	16-4	19-6	16-4	19-6
	Southern Pine	9-9	12-10	16-1	18-10	9-6	12-4	14-8	17-2	14-8	17-2
	Southern Pine	8-1	10-3	12-2	14-6	7-4	9-5	11-1	13-2	11-1	13-2
	Spruce-Pine-Fir	9-6	12-7	16-0	19-6	9-6	12-7	16-0	19-6	16-0	19-6
	Spruce-Pine-Fir	9-4	12-3	15-5	17-10	9-1	11-6	14-1	16-3	14-1	16-3
	Spruce-Pine-Fir	9-4	12-3	15-5	17-10	9-1	11-6	14-1	16-3	14-1	16-3
	Spruce-Pine-Fir	7-6	9-6	11-8	13-6	6-10	8-8	10-7	12-4	10-7	12-4

(continued)

2308.8.3 Framing around openings. Trimmer and header joists shall be doubled, or of lumber of equivalent cross section, where the span of the header exceeds 4 feet (1219 mm). The ends of header joists more than 6 feet (1829 mm) long shall be supported by framing anchors or joist hangers unless bearing on a beam, partition or wall. Tail joists over 12 feet (3658 mm) long shall be supported at the header by framing anchors or on ledger strips not less than 2 inches by 2 inches (51 mm by 51 mm).

2308.8.4 Supporting bearing partitions. Bearing partitions parallel to joists shall be supported on beams, girders, doubled joists, walls or other bearing partitions. Bearing partitions perpendicular to joists shall not be offset from supporting girders, walls or partitions more than the joist depth unless such joists are of sufficient size to carry the additional load.

2308.8.5 Lateral support. Floor, attic and roof framing with a nominal depth-to-thickness ratio greater than or equal to 5:1 shall have one edge held in line for the entire span. Where the nominal depth-to-thickness ratio of the framing member exceeds 6:1, there shall be one line of bridging for each 8 feet (2438 mm) of span, unless both edges of the member are held in line. The bridging shall consist of not less than 1-inch by 3-inch (25 mm by 76 mm) lumber, double nailed at each end, of equivalent metal bracing of equal rigidity, full-depth solid blocking or other approved means. A line of bridging shall also be required at supports where equivalent lateral support is not otherwise provided.

2308.8.6 Structural floor sheathing. Structural floor sheathing shall comply with the provisions of Section 2304.7.1.

2308.8.7 Under-floor ventilation. For under-floor ventilation, see Section 1203.3.

2308.9 Wall framing.

2308.9.1 Size, height and spacing. The size, height and spacing of studs shall be in accordance with Table 2308.9.1 except that utility-grade studs shall not be spaced more than 16 inches (406 mm) o.c., or support more than a roof and

ceiling, or exceed 8 feet (2438 mm) in height for exterior walls and load-bearing walls or 10 feet (3048 mm) for interior nonload-bearing walls.

2308.9.2 Framing details. Studs shall be placed with their wide dimension perpendicular to the wall. Not less than three studs shall be installed at each corner of an exterior wall.

Exception: At corners, two studs are permitted, provided wood spacers or backup cleats of $\frac{3}{8}$ -inch-thick (9.5 mm) wood structural panel, $\frac{3}{8}$ -inch (9.5 mm) Type M “Exterior Glue” particleboard, 1-inch-thick (25 mm) lumber or other approved devices that will serve as an adequate backing for the attachment of facing materials are used. Where fire-resistance ratings or shear values are involved, wood spacers, backup cleats or other devices shall not be used unless specifically approved for such use.

2308.9.2.1 Top plates. Bearing and exterior wall studs shall be capped with double top plates installed to provide overlapping at corners and at intersections with other partitions. End joints in double top plates shall be offset at least 48 inches (1219 mm), and shall be nailed with not less than eight 16d face nails on each side of the joint. Plates shall be a nominal 2 inches (51 mm) in depth and have a width at least equal to the width of the studs.

Exception: A single top plate is permitted, provided the plate is adequately tied at joints, corners and intersecting walls by at least the equivalent of 3-inch by 6-inch (76 mm by 152 mm) by 0.036-inch-thick (0.914 mm) galvanized steel that is nailed to each wall or segment of wall by six 8d nails or equivalent, provided the rafters, joists or trusses are centered over the studs with a tolerance of no more than 1 inch (25 mm).

2308.9.2.2 Top plates for studs spaced at 24 inches (610 mm). Where bearing studs are spaced at 24-inch (610 mm) intervals and top plates are less than two 2-inch by 6-inch (51 mm by 152 mm) or two 3-inch by 4-inch (76 mm by 102 mm) members and where the floor joists, floor trusses or roof trusses that they support are spaced at more than 16-inch (406 mm) intervals, such

TABLE 2308.9.1
SIZE, HEIGHT AND SPACING OF WOOD STUDS

STUD SIZE (inches)	BEARING WALLS				NONBEARING WALLS	
	Laterally unsupported stud height ^a (feet)	Supporting roof and ceiling only	Supporting one floor, roof and ceiling	Supporting two floors, roof and ceiling	Laterally unsupported stud height ^a (feet)	Spacing (inches)
2 × 3 ^b	—	—	—	—	10	16
2 × 4	10	24	16	—	14	24
3 × 4	10	24	24	16	14	24
2 × 5	10	24	24	—	16	24
2 × 6	10	24	24	16	20	24

For SI: 1 inch = 25.4 mm, 1 foot = 304.8 mm.

a. Listed heights are distances between points of lateral support placed perpendicular to the plane of the wall. Increases in unsupported height are permitted where justified by an analysis.

b. Shall not be used in exterior walls.

joists or trusses shall bear within 5 inches (127 mm) of the studs beneath or a third plate shall be installed.

2308.9.2.3 Nonbearing walls and partitions. In nonbearing walls and partitions, studs shall be spaced not more than 28 inches (711 mm) o.c. and are permitted to be set with the long dimension parallel to the wall. Interior nonbearing partitions shall be capped with no less than a single top plate installed to provide overlapping at corners and at intersections with other walls and partitions. The plate shall be continuously tied at joints by solid blocking at least 16 inches (406 mm) in length and equal in size to the plate or by 1/2-inch by 1 1/2-inch (12.7 mm by 38 mm) metal ties with spliced sections fastened with two 16d nails on each side of the joint.

2308.9.2.4 Plates or sills. Studs shall have full bearing on a plate or sill not less than 2 inches (51 mm) in thickness having a width not less than that of the wall studs.

2308.9.3 Bracing. Braced wall lines shall consist of braced wall panels that meet the requirements for location, type and amount of bracing as shown in Figure 2308.9.3, specified in Table 2308.9.3(1) and are in line or offset from each other by not more than 4 feet (1219 mm). Braced wall panels shall start not more than 12 1/2-feet (3810 mm) from each end of a braced wall line. Braced wall panels shall be clearly indicated on the plans. Construction of braced wall panels shall be by one of the following methods:

1. Nominal 1-inch by 4-inch (25 mm by 102 mm) continuous diagonal braces let into top and bottom plates and intervening studs, placed at an angle not more than 60 degrees (1.0 rad) or less than 45 degrees (0.79 rad) from the horizontal and attached to the framing in conformance with Table 2304.9.1.
2. Wood boards of 5/8 inch (15.9 mm) net minimum thickness applied diagonally on studs spaced not over 24 inches (610 mm) o.c.
3. Wood structural panel sheathing with a thickness not less than 5/16 inch (7.9 mm) for a 16-inch (406 mm) stud spacing and not less than 3/8 inch (9.5 mm) for a 24-inch (610 mm) stud spacing in accordance with Tables 2308.9.3(2) and 2308.9.3(3).
4. Fiberboard sheathing panels not less than 1/2 inch (12.7 mm) thick applied vertically or horizontally on studs spaced not over 16 inches (406 mm) o.c. where installed with fasteners in accordance with Section 2306.4.4 and Table 2306.4.4.
5. Gypsum board [sheathing 1/2-inch-thick (12.7 mm) by 4-foot-wide (1219 mm) wallboard or veneer base] on studs spaced not over 24 inches (610 mm) o.c. and nailed at 7 inches (178 mm) o.c. with nails as required by Table 2306.4.5.
6. Particleboard wall sheathing panels where installed in accordance with Table 2308.9.3(4).
7. Portland cement plaster on studs spaced 16 inches (406 mm) o.c. installed in accordance with Section 2510.

8. Hardboard panel siding where installed in accordance with Section 2303.1.6 and Table 2308.9.3(5).

For cripple wall bracing, see Section 2308.9.4.1. For Methods 2, 3, 4, 6, 7 and 8, each panel must be at least 48 inches (1219 mm) in length, covering three stud spaces where studs are spaced 16 inches (406 mm) apart and covering two stud spaces where studs are spaced 24 inches (610 mm) apart.

For Method 5, each panel must be at least 96 inches (2438 mm) in length where applied to one face of a panel and 48 inches (1219 mm) where applied to both faces.

All vertical joints of panel sheathing shall occur over studs and adjacent panel joints shall be nailed to common framing members. Horizontal joints shall occur over blocking or other framing equal in size to the studding except where waived by the installation requirements for the specific sheathing materials.

Sole plates shall be nailed to the floor framing and top plates shall be connected to the framing above in accordance with Section 2308.3.2. Where joists are perpendicular to braced wall lines above, blocking shall be provided under and in line with the braced wall panels.

2308.9.3.1 Alternative bracing. Any bracing required by Section 2308.9.3 is permitted to be replaced by the following:

1. In one-story buildings, each panel shall have a length of not less than 2 feet 8 inches (813 mm) and a height of not more than 10 feet (3048 mm). Each panel shall be sheathed on one face with 3/8-inch-minimum-thickness (9.5 mm) wood structural panel sheathing nailed with 8d common or galvanized box nails in accordance with Table 2304.9.1 and blocked at wood structural panel edges. Two anchor bolts installed in accordance with Section 2308.6 shall be provided in each panel. Anchor bolts shall be placed at each panel outside quarter points. Each panel end stud shall have a tie-down device fastened to the foundation, capable of providing an approved uplift capacity of not less than 1,800 pounds (8006 N). The tie-down device shall be installed in accordance with the manufacturer's recommendations. The panels shall be supported directly on a foundation or on floor framing supported directly on a foundation that is continuous across the entire length of the braced wall line. This foundation shall be reinforced with not less than one No. 4 bar top and bottom.

Where the continuous foundation is required to have a depth greater than 12 inches (305 mm), a minimum 12-inch by 12-inch (305 mm by 305 mm) continuous footing or turned down slab edge is permitted at door openings in the braced wall line. This continuous footing or turned down slab edge shall be reinforced with not less than one No. 4 bar top and bottom. This reinforcement shall be lapped 15 inches (381 mm) with the reinforcement required in the continuous foundation located directly under the braced wall line.

- In the first story of two-story buildings, each wall panel shall be braced in accordance with Section 2308.9.3.1, Item 1, except that the wood structural panel sheathing shall be provided on both faces, three anchor bolts shall be placed at one-quarter points, and tie-down device uplift capacity shall not be less than 3,000 pounds (13 344 N).

2308.9.3.2 Alternate bracing wall panel adjacent to a door or window opening. Any bracing required by Section 2308.9.3 is permitted to be replaced by the following when used adjacent to a door or window opening with a full-length header:

- In one-story buildings, each panel shall have a length of not less than 16 inches (406 mm) and a height of not more than 10 feet (3048 mm). Each panel shall be sheathed on one face with a single layer of $\frac{3}{8}$ inch (9.5 mm) minimum thickness wood structural panel sheathing nailed with 8d common or galvanized box nails in accordance with Figure 2308.9.3.2. The wood structural panel sheathing shall extend up over the solid sawn or glued-laminated header and shall be nailed in accordance with Figure 2308.9.3.2. A built-up header consisting of at least two 2 x 12s and fastened in accordance with Item 24 of Table 2304.9.1 shall be permitted to be used. A spacer, if used, shall be placed on the side of the built-up beam opposite the wood structural panel sheathing. The header shall extend between the inside faces of the first full-length outer studs of each panel. The clear span of the header between the inner studs of each panel shall be not less than 6 feet (1829 mm) and not more than 18 feet (5486 mm) in length. A strap with an uplift capacity of not less than 1,000 pounds (4,400 N) shall fasten the header to the inner studs opposite the sheathing. One anchor bolt not less than $\frac{5}{8}$ inch (15.9 mm) diameter and installed in accordance with Section 2308.6 shall be provided in the center of each sill plate. The studs at each end of the panel shall have a tie-down device fastened to the foundation with an uplift capacity of not less than 4,200 pounds (18 480 N).

Where a panel is located on one side of the opening, the header shall extend between the inside face of the first full-length stud of the panel and the bearing studs at the other end of the opening. A strap with an uplift capacity of not less than 1,000 pounds (4400 N) shall fasten the header to the bearing studs. The bearing studs shall also have a tie-down device fastened to the foundation with an uplift capacity of not less than 1,000 pounds (4400 N).

The tie-down devices shall be an embedded strap type, installed in accordance with the manufacturer's recommendations. The panels shall be supported directly on a foundation that is continuous across the entire length of the braced wall line.

This foundation shall be reinforced with not less than one No. 4 bar top and bottom.

Where the continuous foundation is required to have a depth greater than 12 inches (305 mm), a minimum 12-inch by 12-inch (305 mm by 305 mm) continuous footing or turned down slab edge is permitted at door openings in the braced wall line. This continuous footing or turned down slab edge shall be reinforced with not less than one No. 4 bar top and bottom. This reinforcement shall be lapped not less than 15 inches (381 mm) with the reinforcement required in the continuous foundation located directly under the braced wall line.

- In the first story of two-story buildings, each wall panel shall be braced in accordance with Item 1 above, except that each panel shall have a length of not less than 24 inches (610 mm).

2308.9.4 Cripple walls. Foundation cripple walls shall be framed of studs not less in size than the studding above with a minimum length of 14 inches (356 mm), or shall be framed of solid blocking. Where exceeding 4 feet (1219 mm) in height, such walls shall be framed of studs having the size required for an additional story.

2308.9.4.1 Bracing. For the purposes of this section, cripple walls having a stud height exceeding 14 inches (356 mm) shall be considered a story and shall be braced in accordance with Table 2308.9.3(1) for Seismic Design Category A, B or C. See Section 2308.12.4 for Seismic Design Category D or E.

2308.9.4.2 Nailing of bracing. Spacing of edge nailing for required wall bracing shall not exceed 6 inches (152 mm) o.c. along the foundation plate and the top plate of the cripple wall. Nail size, nail spacing for field nailing and more restrictive boundary nailing requirements shall be as required elsewhere in the code for the specific bracing material used.

2308.9.5 Openings in exterior walls.

2308.9.5.1 Headers. Headers shall be provided over each opening in exterior-bearing walls. The spans in Table 2308.9.5 are permitted to be used for one- and two-family dwellings. Headers for other buildings shall be designed in accordance with Section 2301.2, Item 1 or 2. Headers shall be of two pieces of nominal 2-inch (51 mm) framing lumber set on edge as permitted by Table 2308.9.5 and nailed together in accordance with Table 2304.9.1 or of solid lumber of equivalent size.

2308.9.5.2 Header support. Wall studs shall support the ends of the header in accordance with Table 2308.9.5. Each end of a lintel or header shall have a length of bearing of not less than $1\frac{1}{2}$ inches (38 mm) for the full width of the lintel.

2308.9.6 Openings in interior bearing partitions. Headers shall be provided over each opening in interior bearing partitions as required in Section 2308.9.5. The spans in Table 2308.9.6 are permitted to be used. Wall studs shall support the ends of the header in accordance with Table 2308.9.5 or 2308.9.6, as appropriate.

SEISMIC DESIGN CATEGORY	MAXIMUM WALL SPACING (feet)	REQUIRED BRACING LENGTH, b
A, B and C	35'-0"	Table 2308.9.3(1) and Section 2308.9.3
D and E	25'-0"	Table 2308.12.4

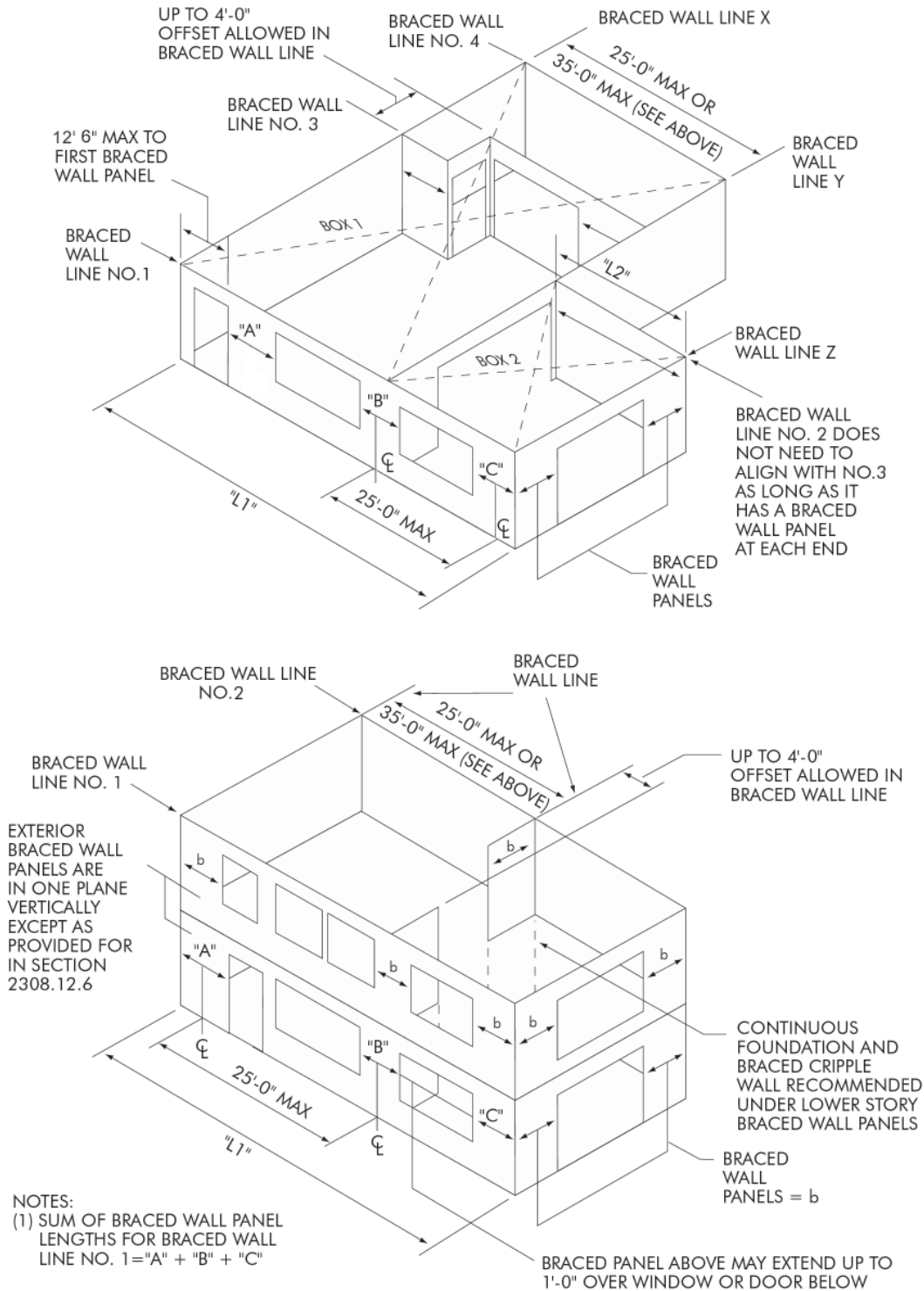

For SI: 1 foot = 304.8 mm.

FIGURE 2308.9.3
BASIC COMPONENTS OF THE LATERAL BRACING SYSTEM

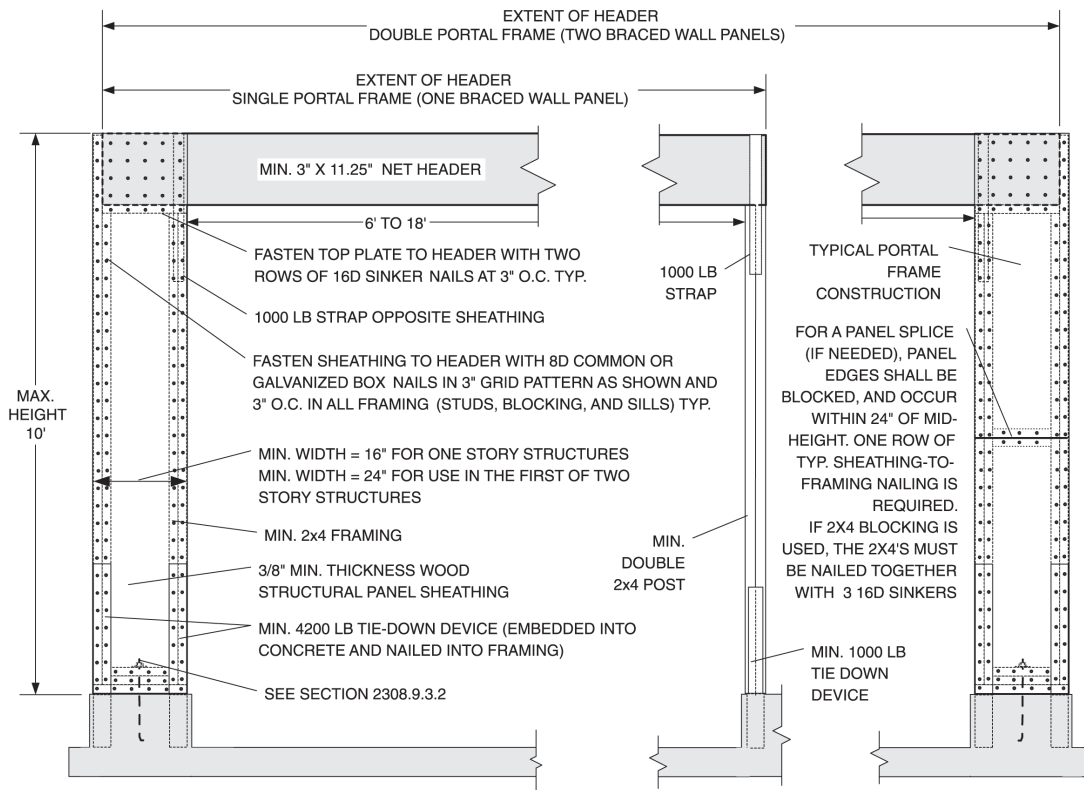

For SI: 1 foot = 304.8 mm; 1 inch = 25.4 mm; 1 pound = 4.448 N.

**FIGURE 2308.9.3.2
ALTERNATE BRACED WALL PANEL ADJACENT TO A DOOR OR WINDOW OPENING**

**TABLE 2308.9.3(1)
BRACED WALL PANELS^a**

SEISMIC DESIGN CATEGORY	CONDITION	CONSTRUCTION METHODS ^{b,c}								BRACED PANEL LOCATION AND LENGTH ^d
		1	2	3	4	5	6	7	8	
A and B	One story, top of two or three story	X	X	X	X	X	X	X	X	Located in accordance with Section 2308.9.3 and not more than 25 feet on center.
	First story of two story or second story of three story	X	X	X	X	X	X	X	X	
	First story of three story	—	X	X	X	X ^e	X	X	X	
C	One story or top of two story	—	X	X	X	X	X	X	X	Located in accordance with Section 2308.9.3 and not more than 25 feet on center.
	First story of two story	—	X	X	X	X ^e	X	X	X	Located in accordance with Section 2308.9.3 and not more than 25 feet on center, but total length shall not be less than 25% of building length ^f .

For SI: 1 inch = 25.4 mm, 1 foot = 304.8 mm.

- a. This table specifies minimum requirements for braced panels that form interior or exterior braced wall lines.
- b. See Section 2308.9.3 for full description.
- c. See Sections 2308.9.3.1 and 2308.9.3.2 for alternative braced panel requirements.
- d. Building length is the dimension parallel to the braced wall length.
- e. Gypsum wallboard applied to framing supports that are spaced at 16 inches on center.
- f. The required lengths shall be doubled for gypsum board applied to only one face of a braced wall panel.

WOOD

TABLE 2308.9.3(2)
EXPOSED PLYWOOD PANEL SIDING

MINIMUM THICKNESS ^a (inch)	MINIMUM NUMBER OF PLYS	STUD SPACING (inches) Plywood siding applied directly to studs or over sheathing
$\frac{3}{8}$	3	16 ^b
$\frac{1}{2}$	4	24

For SI: 1 inch = 25.4 mm.

a. Thickness of grooved panels is measured at bottom of grooves.

b. Spans are permitted to be 24 inches if plywood siding applied with face grain perpendicular to studs or over one of the following: (1) 1-inch board sheathing, (2) $\frac{7}{16}$ -inch wood structural panel sheathing or (3) $\frac{3}{8}$ -inch wood structural panel sheathing with strength axis (which is the long direction of the panel unless otherwise marked) of sheathing perpendicular to studs.

TABLE 2308.9.3(3)
WOOD STRUCTURAL PANEL WALL SHEATHING^b
(Not Exposed to the Weather, Strength Axis Parallel or Perpendicular to Studs Except as Indicated Below)

MINIMUM THICKNESS (inch)	PANEL SPAN RATING	STUD SPACING (inches)		
		Siding nailed to studs	Nailable sheathing	
			Sheathing parallel to studs	Sheathing perpendicular to studs
$\frac{5}{16}$	12/0, 16/0, 20/0 Wall-16" o.c.	16	—	16
$\frac{3}{8}$, $\frac{15}{32}$, $\frac{1}{2}$	16/0, 20/0, 24/0, 32/16 Wall-24" o.c.	24	16	24
$\frac{7}{16}$, $\frac{15}{32}$, $\frac{1}{2}$	24/0, 24/16, 32/16 Wall-24" o.c.	24	24 ^a	24

For SI: 1 inch = 25.4 mm.

a. Plywood shall consist of four or more plies.

b. Blocking of horizontal joints shall not be required except as specified in Sections 2306.4 and 2308.12.4.

TABLE 2308.9.3(4)
ALLOWABLE SPANS FOR PARTICLEBOARD WALL SHEATHING
(Not Exposed to the Weather, Long Dimension of the Panel Parallel or Perpendicular to Studs)

GRADE	THICKNESS (inch)	STUD SPACING (inches)	
		Siding nailed to studs	Sheathing under coverings specified in Section 2308.9.3 parallel or perpendicular to studs
M-S "Exterior Glue" and M-2 "Exterior Glue"	$\frac{3}{8}$	16	—
	$\frac{1}{2}$	16	16

For SI: 1 inch = 25.4 mm.

**TABLE 2308.9.3(5)
HARDBOARD SIDING**

SIDING	MINIMUM NOMINAL THICKNESS (inch)	2 x 4 FRAMING MAXIMUM SPACING	NAIL SIZE ^{a,b,d}	NAIL SPACING	
				General	Bracing panels ^c
1. Lap siding					
Direct to studs	3/8	16" o.c.	8d	16" o.c.	Not applicable
Over sheathing	3/8	16" o.c.	10d	16" o.c.	Not applicable
2. Square edge panel siding					
Direct to studs	3/8	24" o.c.	6d	6" o.c. edges; 12" o.c. at intermediate supports	4" o.c. edges; 8" o.c. at intermediate supports
Over sheathing	3/8	24" o.c.	8d	6" o.c. edges; 12" o.c. at intermediate supports	4" o.c. edges; 8" o.c. at intermediate supports
3. Shiplap edge panel siding					
Direct to studs	3/8	16" o.c.	6d	6" o.c. edges; 12" o.c. at intermediate supports	4" o.c. edges; 8" o.c. at intermediate supports
Over sheathing	3/8	16" o.c.	8d	6" o.c. edges; 12" o.c. At intermediate supports	4" o.c. edges; 8" o.c. at intermediate supports

For SI: 1 inch = 25.4 mm.

a. Nails shall be corrosion resistant.

b. Minimum acceptable nail dimensions:

	Panel Siding (inch)	Lap Siding (inch)
Shank diameter	0.092	0.099
Head diameter	0.225	0.240

c. Where used to comply with Section 2308.9.3.

d. Nail length must accommodate the sheathing and penetrate framing 1 1/2 inches.

2308.9.7 Openings in interior nonbearing partitions.

Openings in nonbearing partitions are permitted to be framed with single studs and headers. Each end of a lintel or header shall have a length of bearing of not less than 1 1/2 inches (38 mm) for the full width of the lintel.

2308.9.8 Pipes in walls. Stud partitions containing plumbing, heating or other pipes shall be so framed and the joists underneath so spaced as to give proper clearance for the piping. Where a partition containing such piping runs parallel to the floor joists, the joists underneath such partitions shall be doubled and spaced to permit the passage of such pipes and shall be bridged. Where plumbing, heating or other pipes are placed in or partly in a partition, necessitating the cutting of the soles or plates, a metal tie not less than 0.058 inch (1.47 mm) (16 galvanized gauge) and 1 1/2 inches (38 mm) wide shall be fastened to each plate across and to each side of the opening with not less than six 16d nails.

2308.9.9 Bridging. Unless covered by interior or exterior wall coverings or sheathing meeting the minimum requirements of this code, stud partitions or walls with studs having a height-to-least-thickness ratio exceeding 50 shall have bridging not less than 2 inches (51 mm) in thickness and of the same width as the studs fitted snugly and nailed thereto to provide adequate lateral support. Bridging shall be placed in every stud cavity and at a frequency such that no stud so braced shall have a height-to-least-thickness ratio exceeding 50 with the height of the stud measured between hori-

zontal framing and bridging or between bridging, whichever is greater.

2308.9.10 Cutting and notching. In exterior walls and bearing partitions, any wood stud is permitted to be cut or notched to a depth not exceeding 25 percent of its width. Cutting or notching of studs to a depth not greater than 40 percent of the width of the stud is permitted in nonbearing partitions supporting no loads other than the weight of the partition.

2308.9.11 Bored holes. A hole not greater in diameter than 40 percent of the stud width is permitted to be bored in any wood stud. Bored holes not greater than 60 percent of the width of the stud are permitted in nonbearing partitions or in any wall where each bored stud is doubled, provided not more than two such successive doubled studs are so bored.

In no case shall the edge of the bored hole be nearer than 5/8 inch (15.9 mm) to the edge of the stud.

Bored holes shall not be located at the same section of stud as a cut or notch.

2308.10 Roof and ceiling framing. The framing details required in this section apply to roofs having a minimum slope of three units vertical in 12 units horizontal (25-percent slope) or greater. Where the roof slope is less than three units vertical in 12 units horizontal (25-percent slope), members supporting rafters and ceiling joists such as ridge board, hips and valleys shall be designed as beams.

TABLE 2308.9.5
HEADER AND GIRDER SPANS^a FOR EXTERIOR BEARING WALLS
 (Maximum Spans for Douglas Fir-Larch, Hem-Fir, Southern Pine and Spruce-Pine-Fir^b and Required Number of Jack Studs)

HEADERS SUPPORTING		GROUND SNOW LOAD (psf) ^c											
		30						50					
		Building width ^c (feet)											
		20		28		36		20		28		36	
SIZE		Span	NJ ^d	Span	NJ ^d	Span	NJ ^d	Span	NJ ^d	Span	NJ ^d	Span	NJ ^d
Roof & Ceiling	2-2 x 4	3-6	1	3-2	1	2-10	1	2-10	1	3-2	1	2-9	1
	2-2 x 6	5-5	1	4-8	1	4-2	1	4-8	1	4-8	1	4-1	1
	2-2 x 8	6-10	1	5-11	2	5-4	2	5-11	2	5-11	2	5-2	2
	2-2 x 10	8-5	2	7-3	2	6-6	2	7-3	2	6-3	2	6-3	2
	2-2 x 12	9-9	2	8-5	2	7-6	2	8-5	2	7-3	2	7-3	2
	3-2 x 8	8-4	1	7-5	1	6-8	1	7-5	1	6-5	2	6-5	2
	3-2 x 10	10-6	1	9-1	2	8-2	2	9-1	2	7-10	2	7-10	2
	3-2 x 12	12-2	2	10-7	2	9-5	2	10-7	2	9-2	2	8-2	2
	4-2 x 8	9-2	1	8-4	1	7-8	1	8-4	1	7-5	1	6-8	1
	4-2 x 10	11-8	1	10-6	1	9-5	2	10-6	1	9-1	2	8-2	2
	4-2 x 12	14-1	1	12-2	2	10-11	2	12-2	2	10-7	2	9-5	2
	Roof, Ceiling & 1 Center-Bearing Floor	2-2 x 4	3-1	1	2-9	1	2-5	1	2-9	1	2-9	1	2-5
2-2 x 6		4-6	1	4-0	1	3-7	2	4-1	1	3-7	2	3-3	2
2-2 x 8		5-9	2	5-0	2	4-6	2	5-2	2	4-6	2	4-1	2
2-2 x 10		7-0	2	6-2	2	5-6	2	6-4	2	5-6	2	5-0	2
2-2 x 12		8-1	2	7-1	2	6-5	2	7-4	2	6-5	2	5-9	3
3-2 x 8		7-2	1	6-3	2	5-8	2	6-5	2	5-8	2	5-1	2
3-2 x 10		8-9	2	7-8	2	6-11	2	7-11	2	6-11	2	6-3	2
3-2 x 12		10-2	2	8-11	2	8-0	2	9-2	2	8-0	2	7-3	2
4-2 x 8		8-1	1	7-3	1	6-7	1	7-5	1	6-6	1	5-11	2
4-2 x 10		10-1	1	8-10	2	8-0	2	9-1	2	8-0	2	7-2	2
4-2 x 12		11-9	2	10-3	2	9-3	2	10-7	2	9-3	2	8-4	2
2-2 x 4		2-8	1	2-4	1	2-1	1	2-7	1	2-3	1	2-0	1
Roof, Ceiling & 1 Clear Span Floor	2-2 x 6	3-11	1	3-5	2	3-0	2	3-10	2	3-4	2	3-0	2
	2-2 x 8	5-0	2	4-4	2	3-10	2	4-10	2	4-2	2	3-9	2
	2-2 x 10	6-1	2	5-3	2	4-8	2	5-11	2	5-1	2	4-7	3
	2-2 x 12	7-1	2	6-1	3	5-5	3	6-10	2	5-11	3	5-4	3
	3-2 x 8	6-3	2	5-5	2	4-10	2	6-1	2	5-3	2	4-8	2
	3-2 x 10	7-7	2	6-7	2	5-11	2	7-5	2	6-5	2	5-9	2
	3-2 x 12	8-10	2	7-8	2	6-10	2	8-7	2	7-5	2	6-8	2
	4-2 x 8	7-2	1	6-3	2	5-7	2	7-0	1	6-1	2	5-5	2
	4-2 x 10	8-9	2	7-7	2	6-10	2	8-7	2	7-5	2	6-7	2
	4-2 x 12	10-2	2	8-10	2	7-11	2	9-11	2	8-7	2	7-8	2

(continued)

TABLE 2308.9.5—continued
HEADER AND GIRDER SPANS^a FOR EXTERIOR BEARING WALLS
(Maximum Spans for Douglas Fir-Larch, Hem-Fir, Southern Pine and Spruce-Pine-Fir^b and Required Number of Jack Studs)

HEADERS SUPPORTING	SIZE	GROUND SNOW LOAD (psf) ^c											
		30				50							
		Building width ^d (feet)											
20		28		36		20		28		36			
Span	NJ ^e	Span	NJ ^e	Span	NJ ^e	Span	NJ ^e	Span	NJ ^e	Span	NJ ^e		
Roof, Ceiling & 2 Center-Bearing Floors	2-2 x 4	2-7	1	2-3	1	2-0	1	2-6	1	2-2	1	1-11	1
	2-2 x 6	3-9	2	3-3	2	2-11	2	3-8	2	3-2	2	2-10	2
	2-2 x 8	4-9	2	4-2	2	3-9	2	4-7	2	4-0	2	3-8	2
	2-2 x 10	5-9	2	5-1	2	4-7	3	5-8	2	4-11	2	4-5	3
	2-2 x 12	6-8	2	5-10	3	5-3	3	6-6	2	5-9	3	5-2	3
	3-2 x 8	5-11	2	5-2	2	4-8	2	5-9	2	5-1	2	4-7	2
	3-2 x 10	7-3	2	6-4	2	5-8	2	7-1	2	6-2	2	5-7	2
	3-2 x 12	8-5	2	7-4	2	6-7	2	8-2	2	7-2	2	6-5	3
	4-2 x 8	6-10	1	6-0	2	5-5	2	6-8	1	5-10	2	5-3	2
	4-2 x 10	8-4	2	7-4	2	6-7	2	8-2	2	7-2	2	6-5	2
	4-2 x 12	9-8	2	8-6	2	7-8	2	9-5	2	8-3	2	7-5	2
	2-2 x 4	2-1	1	1-8	1	1-6	2	2-0	1	1-8	1	1-5	2
	2-2 x 6	3-1	2	2-8	2	2-4	2	3-0	2	2-7	2	2-3	2
	2-2 x 8	3-10	2	3-4	2	3-0	3	3-10	2	3-4	2	2-11	3
	2-2 x 10	4-9	2	4-1	3	3-8	3	4-8	2	4-0	3	3-7	3
2-2 x 12	5-6	3	4-9	3	4-3	3	5-5	3	4-8	3	4-2	3	
3-2 x 8	4-10	2	4-2	2	3-9	2	4-9	2	4-1	2	3-8	2	
3-2 x 10	5-11	2	5-1	2	4-7	3	5-10	2	5-0	2	4-6	3	
3-2 x 12	6-10	2	5-11	3	5-4	3	6-9	2	5-10	3	5-3	3	
4-2 x 8	5-7	2	4-10	2	4-4	2	5-6	2	4-9	2	4-3	2	
4-2 x 10	6-10	2	5-11	2	5-3	2	6-9	2	5-10	2	5-2	2	
4-2 x 12	7-11	2	6-10	2	6-2	3	7-9	2	6-9	2	6-0	3	

For SI: 1 inch = 25.4 mm, 1 foot = 304.8 mm, 1 pound per square foot = 47.8 N/m².

- a. Spans are given in feet and inches (ft-in).
- b. Tabulated values are for No. 2 grade lumber.
- c. Building width is measured perpendicular to the ridge. For widths between those shown, spans are permitted to be interpolated.
- d. NJ - Number of jack studs required to support each end. Where the number of required jack studs equals one, the header is permitted to be supported by an approved framing anchor attached to the full-height wall stud and to the header.
- e. Use 30 pounds per square foot ground snow load for cases in which ground snow load is less than 30 pounds per square foot and the roof live load is equal to or less than 20 pounds per square foot.

TABLE 2308.9.6
HEADER AND GIRDER SPANS^a FOR INTERIOR BEARING WALLS
 (Maximum Spans for Douglas Fir-Larch, Hem-Fir, Southern Pine and Spruce-Pine-Fir^b and Required Number of Jack Studs)

HEADERS AND GIRDERS SUPPORTING	SIZE	BUILDING WIDTH ^c (feet)					
		20		28		36	
		Span	NJ ^d	Span	NJ ^d	Span	NJ ^d
One Floor Only	2-2 × 4	3-1	1	2-8	1	2-5	1
	2-2 × 6	4-6	1	3-11	1	3-6	1
	2-2 × 8	5-9	1	5-0	2	4-5	2
	2-2 × 10	7-0	2	6-1	2	5-5	2
	2-2 × 12	8-1	2	7-0	2	6-3	2
	3-2 × 8	7-2	1	6-3	1	5-7	2
	3-2 × 10	8-9	1	7-7	2	6-9	2
	3-2 × 12	10-2	2	8-10	2	7-10	2
	4-2 × 8	9-0	1	7-8	1	6-9	1
	4-2 × 10	10-1	1	8-9	1	7-10	2
Two Floors	2-2 × 4	2-2	1	1-10	1	1-7	1
	2-2 × 6	3-2	2	2-9	2	2-5	2
	2-2 × 8	4-1	2	3-6	2	3-2	2
	2-2 × 10	4-11	2	4-3	2	3-10	3
	2-2 × 12	5-9	2	5-0	3	4-5	3
	3-2 × 8	5-1	2	4-5	2	3-11	2
	3-2 × 10	6-2	2	5-4	2	4-10	2
	3-2 × 12	7-2	2	6-3	2	5-7	3
	4-2 × 8	6-1	1	5-3	2	4-8	2
	4-2 × 10	7-2	2	6-2	2	5-6	2
4-2 × 12	8-4	2	7-2	2	6-5	2	

For SI: 1 inch = 25.4 mm, 1 foot = 304.8 mm.

a. Spans are given in feet and inches (ft-in).

b. Tabulated values are for No. 2 grade lumber.

c. Building width is measured perpendicular to the ridge. For widths between those shown, spans are permitted to be interpolated.

d. NJ - Number of jack studs required to support each end. Where the number of required jack studs equals one, the headers are permitted to be supported by an approved framing anchor attached to the full-height wall stud and to the header.

TABLE 2308.10.1
REQUIRED RATING OF APPROVED UPLIFT CONNECTORS (pounds)^{a,b,c,e,f,g,h}

BASIC WIND SPEED (3-second gust)	ROOF SPAN (feet)							OVERHANGS (pounds/feet) ^d
	12	20	24	28	32	36	40	
85	-72	-120	-145	-169	-193	-217	-241	-38.55
90	-91	-151	-181	-212	-242	-272	-302	-43.22
100	-131	-281	-262	-305	-349	-393	-436	-53.36
110	-175	-292	-351	-409	-467	-526	-584	-64.56

For SI: 1 inch = 25.4 mm, 1 foot = 304.8 mm, 1 mile per hour = 1.61 km/hr, 1 pound = 0.454 Kg, 1 pound/foot = 14.5939 N/m.

a. The uplift connection requirements are based on a 30-foot mean roof height located in Exposure B. For Exposure C or D and for other mean roof heights, multiply the above loads by the adjustment coefficients below.

EXPOSURE	Mean Roof Height (feet)									
	15	20	25	30	35	40	45	50	55	60
B	1.00	1.00	1.00	1.00	1.05	1.09	1.12	1.16	1.19	1.22
C	1.21	1.29	1.35	1.40	1.45	1.49	1.53	1.56	1.59	1.62
D	1.47	1.55	1.61	1.66	1.70	1.74	1.78	1.81	1.84	1.87

- b. The uplift connection requirements are based on the framing being spaced 24 inches on center. Multiply by 0.67 for framing spaced 16 inches on center and multiply by 0.5 for framing spaced 12 inches on center.
- c. The uplift connection requirements include an allowance for 10 pounds of dead load.
- d. The uplift connection requirements do not account for the effects of overhangs. The magnitude of the above loads shall be increased by adding the overhang loads found in the table. The overhang loads are also based on framing spaced 24 inches on center. The overhang loads given shall be multiplied by the overhang projection and added to the roof uplift value in the table.
- e. The uplift connection requirements are based upon wind loading on end zones as defined in Figure 6-2 of ASCE 7. Connection loads for connections located a distance of 20 percent of the least horizontal dimension of the building from the corner of the building are permitted to be reduced by multiplying the table connection value by 0.7 and multiplying the overhang load by 0.8.
- f. For wall-to-wall and wall-to-foundation connections, the capacity of the uplift connector is permitted to be reduced by 100 pounds for each full wall above. (For example, if a 500-pound rated connector is used on the roof framing, a 400-pound rated connector is permitted at the next floor level down).
- g. Interpolation is permitted for intermediate values of basic wind speeds and roof spans.
- h. The rated capacity of approved tie-down devices is permitted to include up to a 60-percent increase for wind effects where allowed by material specifications.

2308.10.1 Wind uplift. Roof assemblies shall have rafter and truss ties to the wall below. Resultant uplift loads shall be transferred to the foundation using a continuous load path. The rafter or truss to wall connection shall comply with Tables 2304.9.1 and 2308.10.1.

2308.10.2 Ceiling joist spans. Allowable spans for ceiling joists shall be in accordance with Table 2308.10.2(1) or 2308.10.2(2). For other grades and species, refer to the *AF&PA Span Tables for Joists and Rafters*.

2308.10.3 Rafter spans. Allowable spans for rafters shall be in accordance with Table 2308.10.3(1), 2308.10.3(2), 2308.10.3(3), 2308.10.3(4), 2308.10.3(5) or 2308.10.3(6). For other grades and species, refer to the *AF&PA Span Tables for Joists and Rafters*.

2308.10.4 Ceiling joist and rafter framing. Rafters shall be framed directly opposite each other at the ridge. There shall be a ridge board at least 1-inch (25 mm) nominal thickness at ridges and not less in depth than the cut end of the rafter. At valleys and hips, there shall be a single valley or hip rafter not less than 2-inch (51 mm) nominal thickness and not less in depth than the cut end of the rafter.

2308.10.4.1 Ceiling joist and rafter connections. Ceiling joists and rafters shall be nailed to each other and the assembly shall be nailed to the top wall plate in accordance with Tables 2304.9.1 and 2308.10.1. Ceiling joists shall be continuous or securely joined where they meet over interior partitions and fastened to adjacent rafters in accordance with Tables 2308.10.4.1 and 2304.9.1 to

provide a continuous rafter tie across the building where such joists are parallel to the rafters. Ceiling joists shall have a bearing surface of not less than 1½ inches (38 mm) on the top plate at each end.

Where ceiling joists are not parallel to rafters, an equivalent rafter tie shall be installed in a manner to provide a continuous tie across the building, at a spacing of not more than 4 feet (1219 mm) o.c. The connections shall be in accordance with Tables 2308.10.4.1 and 2304.9.1, or connections of equivalent capacities shall be provided. Where ceiling joists or rafter ties are not provided at the top of the rafter support walls, the ridge formed by these rafters shall also be supported by a girder conforming to Section 2308.4.

Rafter ties shall be spaced not more than 4 feet (1219 mm) o.c. Rafter tie connections shall be based on the equivalent rafter spacing in Table 2308.10.4.1. Where rafter ties are spaced at 32 inches (813 mm) o.c., the number of 16d common nails shall be two times the number specified for rafters spaced 16 inches (406 mm) o.c., with a minimum of 4-16d common nails where no snow loads are indicated. Where rafter ties are spaced at 48 inches (1219 mm) o.c., the number of 16d common nails shall be two times the number specified for rafters spaced 24 inches (610 mm) o.c., with a minimum of 6-16d common nails where no snow loads are indicated. Rafter/ceiling joist connections and rafter/tie connections shall be of sufficient size and number to prevent splitting from nailing.

TABLE 2308.10.2(1)
 CEILING JOIST SPANS FOR COMMON LUMBER SPECIES
 (Uninhabitable Attics Without Storage, Live Load = 10 pounds psf, L/Δ = 240)

CEILING JOIST SPACING (inches)	SPECIES AND GRADE	DEAD LOAD = 5 pounds per square foot			
		2 x 4	2 x 6	2 x 8	
		(ft. - in.)	(ft. - in.)	(ft. - in.)	
				Maximum ceiling joist spans (ft. - in.)	2 x 10 (ft. - in.)
12	Douglas Fir-Larch SS	13-2	20-8	Note a	Note a
	Douglas Fir-Larch #1	12-8	19-11	Note a	Note a
	Douglas Fir-Larch #2	12-5	19-6	25-8	Note a
	Douglas Fir-Larch #3	10-10	15-10	20-1	24-6
	Hem-Fir SS	12-5	19-6	25-8	Note a
	Hem-Fir #1	12-2	19-1	25-2	Note a
	Hem-Fir #2	11-7	18-2	24-0	Note a
	Hem-Fir #3	10-10	15-10	20-1	24-6
	Southern Pine SS	12-11	20-3	Note a	Note a
	Southern Pine #1	12-8	19-11	Note a	Note a
	Southern Pine #2	12-5	19-6	25-8	Note a
	Southern Pine #3	11-6	17-0	21-8	25-7
16	Spruce-Pine-Fir SS	12-2	19-1	25-2	Note a
	Spruce-Pine-Fir #1	11-10	18-8	24-7	Note a
	Spruce-Pine-Fir #2	11-10	18-8	24-7	Note a
	Spruce-Pine-Fir #3	10-10	15-10	20-1	24-6
	Douglas Fir-Larch SS	11-11	18-9	24-8	Note a
	Douglas Fir-Larch #1	11-6	18-1	23-10	Note a
	Douglas Fir-Larch #2	11-3	17-8	23-0	Note a
	Douglas Fir-Larch #3	9-5	13-9	17-5	21-3
	Hem-Fir SS	11-3	17-8	23-4	Note a
	Hem-Fir #1	11-0	17-4	22-10	Note a
	Hem-Fir #2	10-6	16-6	21-9	Note a
	Hem-Fir #3	9-5	13-9	17-5	21-3
16	Southern Pine SS	11-9	18-5	24-3	Note a
	Southern Pine #1	11-6	18-1	23-1	Note a
	Southern Pine #2	11-3	17-8	23-4	Note a
	Southern Pine #3	10-0	14-9	18-9	22-2
	Spruce-Pine-Fir SS	11-0	17-4	22-10	Note a
	Spruce-Pine-Fir #1	10-9	16-11	22-4	Note a
	Spruce-Pine-Fir #2	10-9	16-11	22-4	Note a
	Spruce-Pine-Fir #3	9-5	13-9	17-5	21-3

(continued)

TABLE 2308.10.2(1)—continued
CEILING JOIST SPANS FOR COMMON LUMBER SPECIES
 (Uninhabitable Attics Without Storage, Live Load = 10 pounds psf, L/Δ = 240)

CEILING JOIST SPACING (Inches)	SPECIES AND GRADE	DEAD LOAD = 5 pounds per square foot			
		2 x 4	2 x 6	2 x 8	2 x 10
		(ft. - in.)	(ft. - in.)	Maximum ceiling joist spans (ft. - in.)	(ft. - in.)
19.2	Douglas Fir-Larch SS	11-3	17-8	23-3	Note a
	Douglas Fir-Larch #1	10-10	17-0	22-5	Note a
	Douglas Fir-Larch #2	10-7	16-7	21-0	25-8
	Douglas Fir-Larch #3	8-7	12-6	15-10	19-5
	Hem-Fir SS	10-7	16-8	21-11	Note a
	Hem-Fir #1	10-4	16-4	21-6	Note a
	Hem-Fir #2	9-11	15-7	20-6	25-3
	Hem-Fir #3	8-7	12-6	15-10	19-5
	Southern Pine SS	11-0	17-4	22-10	Note a
	Southern Pine #1	10-10	17-0	22-5	Note a
	Southern Pine #2	10-7	16-8	21-11	Note a
	Southern Pine #3	9-1	13-6	17-2	20-3
	Spruce-Pine-Fir SS	10-4	16-4	21-6	Note a
	Spruce-Pine-Fir #1	10-2	15-11	21-0	25-8
	Spruce-Pine-Fir #2	10-2	15-11	21-0	25-8
	Spruce-Pine-Fir #3	8-7	12-6	15-10	19-5
	Douglas Fir-Larch SS	10-5	16-4	21-7	Note a
	Douglas Fir-Larch #1	10-0	15-9	20-1	24-6
	Douglas Fir-Larch #2	9-10	14-10	18-9	22-11
Douglas Fir-Larch #3	7-8	11-2	14-2	17-4	
24	Hem-Fir SS	9-10	15-6	20-5	Note a
	Hem-Fir #1	9-8	15-2	19-7	23-11
	Hem-Fir #2	9-2	14-5	18-6	22-7
	Hem-Fir #3	7-8	11-2	14-2	17-4
	Southern Pine SS	10-3	16-1	21-2	Note a
	Southern Pine #1	10-0	15-9	20-10	Note a
	Southern Pine #2	9-10	15-6	20-1	23-11
	Southern Pine #3	8-2	12-0	15-4	18-1
	Spruce-Pine-Fir SS	9-8	15-2	19-11	25-5
	Spruce-Pine-Fir #1	9-5	14-9	18-9	22-11
	Spruce-Pine-Fir #2	9-5	14-9	18-9	22-11
	Spruce-Pine-Fir #3	7-8	11-2	14-2	17-4

For SI: 1 inch = 25.4 mm, 1 foot = 304.8 mm, 1 pound per square foot = 47.8 N/m².
 a. Span exceeds 26 feet in length. Check sources for availability of lumber in lengths greater than 20 feet.

TABLE 2308.10.2(2)
CEILING JOIST SPANS FOR COMMON LUMBER SPECIES
 (Uninhabitable Attics With Limited Storage, Live Load = 20 pounds per square foot, $L/\Delta = 240$)

CEILING JOIST SPACING (inches)	SPECIES AND GRADE	DEAD LOAD = 10 pounds per square foot			
		2 x 4 (ft. - in.)	2 x 6 (ft. - in.)	2 x 8 (ft. - in.)	
12	Douglas Fir-Larch SS	10-5	16-4	21-7	
	Douglas Fir-Larch #1	10-0	15-9	20-1	
	Douglas Fir-Larch #2	9-10	14-10	18-9	
	Douglas Fir-Larch #3	7-8	11-2	14-2	
	Hem-Fir SS	9-10	15-6	20-5	
	Hem-Fir #1	9-8	15-2	19-7	
	Hem-Fir #2	9-2	14-5	18-6	
	Hem-Fir #3	7-8	11-2	14-2	
	Southern Pine SS	10-3	16-1	21-2	
	Southern Pine #1	10-0	15-9	20-10	
	Southern Pine #2	9-10	15-6	20-1	
	Southern Pine #3	8-2	12-0	15-4	
	Spruce-Pine-Fir SS	9-8	15-2	19-11	
	Spruce-Pine-Fir #1	9-5	14-9	18-9	
	Spruce-Pine-Fir #2	9-5	14-9	18-9	
	Spruce-Pine-Fir #3	7-8	11-2	14-2	
	16	Douglas Fir-Larch SS	9-6	14-11	19-7
		Douglas Fir-Larch #1	9-1	13-9	17-5
Douglas Fir-Larch #2		8-9	12-10	16-3	
Douglas Fir-Larch #3		6-8	9-8	12-4	
Hem-Fir SS		8-11	14-1	18-6	
Hem-Fir #1		8-9	13-5	16-10	
Hem-Fir #2		8-4	12-8	16-0	
Hem-Fir #3		6-8	9-8	12-4	
Southern Pine SS		9-4	14-7	19-3	
Southern Pine #1		9-1	14-4	18-11	
Southern Pine #2		8-11	13-6	17-5	
Southern Pine #3		7-1	10-5	13-3	
Spruce-Pine-Fir SS		8-9	13-9	18-1	
Spruce-Pine-Fir #1		8-7	12-10	16-3	
Spruce-Pine-Fir #2		8-7	12-10	16-3	
Spruce-Pine-Fir #3		6-8	9-8	12-4	

(continued)

TABLE 2308.10.2(2)—continued
CEILING JOIST SPANS FOR COMMON LUMBER SPECIES
 (Uninhabitable Attics With Limited Storage, Live Load = 20 pounds per square foot, L/Δ = 240)

CEILING JOIST SPACING (inches)	SPECIES AND GRADE	DEAD LOAD = 10 pounds per square foot			
		2 x 4	2 x 6	2 x 8	2 x 10
		(ft. - in.)	(ft. - in.)	(ft. - in.)	(ft. - in.)
19.2	Douglas Fir-Larch SS	8-11	14-0	18-5	23-4
	Douglas Fir-Larch #1	8-7	12-6	15-10	19-5
	Douglas Fir-Larch #2	8-0	11-9	14-10	18-2
	Douglas Fir-Larch #3	6-1	8-10	11-3	13-8
	Hem-Fir SS	8-5	13-3	17-5	22-3
	Hem-Fir #1	8-3	12-3	15-6	18-11
	Hem-Fir #2	7-10	11-7	14-8	17-10
	Hem-Fir #3	6-1	8-10	11-3	13-8
	Southern Pine SS	8-9	13-9	18-1	23-1
	Southern Pine #1	8-7	13-6	17-9	21-1
	Southern Pine #2	8-5	12-3	15-10	18-11
	Southern Pine #3	6-5	9-6	12-1	14-4
	Spruce-Pine-Fir SS	8-3	12-11	17-1	21-8
	Spruce-Pine-Fir #1	8-0	11-9	14-10	18-2
	Spruce-Pine-Fir #2	8-0	11-9	14-10	18-2
	Spruce-Pine-Fir #3	6-1	8-10	11-3	13-8
	Douglas Fir-Larch SS	8-3	13-0	17-1	20-11
	Douglas Fir-Larch #1	7-8	11-2	14-2	17-4
	Douglas Fir-Larch #2	7-2	10-6	13-3	16-3
Douglas Fir-Larch #3	5-5	7-11	10-0	12-3	
24	Hem-Fir SS	7-10	12-3	16-2	20-6
	Hem-Fir #1	7-6	10-11	13-10	16-11
	Hem-Fir #2	7-1	10-4	13-1	16-0
	Hem-Fir #3	5-5	7-11	10-0	12-3
	Southern Pine SS	8-1	12-9	16-10	21-6
	Southern Pine #1	8-0	12-6	15-10	18-10
	Southern Pine #2	7-8	11-0	14-2	16-11
	Southern Pine #3	5-9	8-6	10-10	12-10
	Spruce-Pine-Fir SS	7-8	12-0	15-10	19-5
	Spruce-Pine-Fir #1	7-2	10-6	13-3	16-3
	Spruce-Pine-Fir #2	7-2	10-6	13-3	16-3
	Spruce-Pine-Fir #3	5-5	7-11	10-0	12-3

For SI: 1 inch = 25.4 mm, 1 foot = 304.8 mm, 1 pound per square foot = 47.8 N/m².
 a. Span exceeds 26 feet in length. Check sources for availability of lumber in lengths greater than 20 feet.

TABLE 2308.10.3(1)
RAFTER SPANS FOR COMMON LUMBER SPECIES
 (Roof Live Load = 20 pounds per square foot, Ceiling Not Attached to Rafters, L/Δ = 180)

RAFTER SPACING (inches)	DEAD LOAD = 10 pounds per square foot										DEAD LOAD = 20 pounds per square foot									
	2 x 4		2 x 6		2 x 8		2 x 10		2 x 12		2 x 4		2 x 6		2 x 8		2 x 10		2 x 12	
	(ft. - in.)	(ft. - in.)	(ft. - in.)	(ft. - in.)	(ft. - in.)	(ft. - in.)	(ft. - in.)	(ft. - in.)	(ft. - in.)	(ft. - in.)	(ft. - in.)	(ft. - in.)	(ft. - in.)	(ft. - in.)	(ft. - in.)	(ft. - in.)	(ft. - in.)	(ft. - in.)	(ft. - in.)	(ft. - in.)
	Maximum rafter spans																			
	(ft. - in.)	(ft. - in.)	(ft. - in.)	(ft. - in.)	(ft. - in.)	(ft. - in.)	(ft. - in.)	(ft. - in.)	(ft. - in.)	(ft. - in.)	(ft. - in.)	(ft. - in.)	(ft. - in.)	(ft. - in.)	(ft. - in.)	(ft. - in.)	(ft. - in.)	(ft. - in.)	(ft. - in.)	(ft. - in.)
	11-6	18-0	23-9	Note a	Note a	11-6	18-0	23-5	Note a	Note a	11-6	18-0	23-5	Note a	Note a	11-6	18-0	23-5	Note a	Note a
	11-1	17-4	22-5	Note a	Note a	10-6	15-4	19-5	Note a	Note a	10-6	15-4	19-5	Note a	Note a	10-6	15-4	19-5	Note a	Note a
	10-10	16-7	21-0	25-8	Note a	9-10	14-4	18-2	22-3	Note a	9-10	14-4	18-2	22-3	Note a	9-10	14-4	18-2	22-3	25-9
	8-7	12-6	15-10	19-5	Note a	7-5	10-10	13-9	16-9	Note a	7-5	10-10	13-9	16-9	Note a	7-5	10-10	13-9	16-9	19-6
	10-10	17-0	22-5	Note a	Note a	10-10	17-0	22-5	Note a	Note a	10-10	17-0	22-5	Note a	Note a	10-10	17-0	22-5	Note a	Note a
	10-7	16-8	21-10	Note a	Note a	10-3	14-11	18-11	23-2	Note a	10-3	14-11	18-11	23-2	Note a	10-3	14-11	18-11	23-2	Note a
	10-1	15-11	20-8	25-3	Note a	9-8	14-2	17-11	21-11	Note a	9-8	14-2	17-11	21-11	Note a	9-8	14-2	17-11	21-11	25-5
	8-7	12-6	15-10	19-5	Note a	7-5	10-10	13-9	16-9	Note a	7-5	10-10	13-9	16-9	Note a	7-5	10-10	13-9	16-9	19-6
12	11-3	17-8	23-4	Note a	Note a	11-3	17-8	23-4	Note a	Note a	11-3	17-8	23-4	Note a	Note a	11-3	17-8	23-4	Note a	Note a
	11-1	17-4	22-11	Note a	Note a	11-1	17-3	21-9	25-10	Note a	11-1	17-3	21-9	25-10	Note a	11-1	17-3	21-9	25-10	Note a
	10-10	17-0	22-5	Note a	Note a	10-6	15-1	19-5	23-2	Note a	10-6	15-1	19-5	23-2	Note a	10-6	15-1	19-5	23-2	Note a
	9-1	13-6	17-2	20-3	Note a	7-11	11-8	14-10	17-6	Note a	7-11	11-8	14-10	17-6	Note a	7-11	11-8	14-10	17-6	20-11
	10-7	16-8	21-11	Note a	Note a	10-7	16-8	21-9	Note a	Note a	10-7	16-8	21-9	Note a	Note a	10-7	16-8	21-9	Note a	Note a
	10-4	16-3	21-0	25-8	Note a	9-10	14-4	18-2	22-3	Note a	9-10	14-4	18-2	22-3	Note a	9-10	14-4	18-2	22-3	25-9
	10-4	16-3	21-0	25-8	Note a	9-10	14-4	18-2	22-3	Note a	9-10	14-4	18-2	22-3	Note a	9-10	14-4	18-2	22-3	25-9
	8-7	12-6	15-10	19-5	Note a	7-5	10-10	13-9	16-9	Note a	7-5	10-10	13-9	16-9	Note a	7-5	10-10	13-9	16-9	19-6
	10-5	16-4	21-7	Note a	Note a	10-5	16-0	20-3	24-9	Note a	10-5	16-0	20-3	24-9	Note a	10-5	16-0	20-3	24-9	Note a
	10-0	15-4	19-5	23-9	Note a	9-1	13-3	16-10	20-7	Note a	9-1	13-3	16-10	20-7	Note a	9-1	13-3	16-10	20-7	23-10
	9-10	14-4	18-2	22-3	Note a	8-6	12-5	15-9	19-3	Note a	8-6	12-5	15-9	19-3	Note a	8-6	12-5	15-9	19-3	22-4
	7-5	10-10	13-9	16-9	Note a	6-5	9-5	11-11	14-6	Note a	6-5	9-5	11-11	14-6	Note a	6-5	9-5	11-11	14-6	16-10
	9-10	15-6	20-5	Note a	Note a	9-10	15-6	19-11	24-4	Note a	9-10	15-6	19-11	24-4	Note a	9-10	15-6	19-11	24-4	Note a
	9-8	14-11	18-11	23-2	Note a	8-10	12-11	16-5	20-0	Note a	8-10	12-11	16-5	20-0	Note a	8-10	12-11	16-5	20-0	23-3
	9-2	14-2	17-11	21-11	Note a	8-5	12-3	15-6	18-11	Note a	8-5	12-3	15-6	18-11	Note a	8-5	12-3	15-6	18-11	22-0
	7-5	10-10	13-9	16-9	Note a	6-5	9-5	11-11	14-6	Note a	6-5	9-5	11-11	14-6	Note a	6-5	9-5	11-11	14-6	16-10
	10-3	16-1	21-2	Note a	Note a	10-3	16-1	21-2	Note a	Note a	10-3	16-1	21-2	Note a	Note a	10-3	16-1	21-2	Note a	Note a
16	10-0	15-9	20-10	25-10	Note a	10-0	15-0	18-10	22-4	Note a	10-0	15-0	18-10	22-4	Note a	10-0	15-0	18-10	22-4	Note a
	9-10	15-1	19-5	23-2	Note a	9-1	13-0	16-10	20-1	Note a	9-1	13-0	16-10	20-1	Note a	9-1	13-0	16-10	20-1	23-7
	7-11	11-8	14-10	17-6	Note a	6-10	10-1	12-10	15-2	Note a	6-10	10-1	12-10	15-2	Note a	6-10	10-1	12-10	15-2	18-1
	9-8	15-2	19-11	25-5	Note a	9-8	14-10	18-10	23-0	Note a	9-8	14-10	18-10	23-0	Note a	9-8	14-10	18-10	23-0	Note a
	9-5	14-4	18-2	22-3	Note a	8-6	12-5	15-9	19-3	Note a	8-6	12-5	15-9	19-3	Note a	8-6	12-5	15-9	19-3	22-4
	9-5	14-4	18-2	22-3	Note a	8-6	12-5	15-9	19-3	Note a	8-6	12-5	15-9	19-3	Note a	8-6	12-5	15-9	19-3	22-4
	7-5	10-10	13-9	16-9	Note a	6-5	9-5	11-11	14-6	Note a	6-5	9-5	11-11	14-6	Note a	6-5	9-5	11-11	14-6	16-10

(continued)

TABLE 2308.10.3(1)—continued
RAFTER SPANS FOR COMMON LUMBER SPECIES
 (Roof Live Load = 20 pounds per square foot, Ceiling Not Attached to Rafters, $L/\Delta = 180$)

RAFTER SPACING (inches)	DEAD LOAD = 10 pounds per square foot										DEAD LOAD = 20 pounds per square foot									
	2 x 4		2 x 6		2 x 8		2 x 10		2 x 12		2 x 4		2 x 6		2 x 8		2 x 10		2 x 12	
	(ft. - in.)	(ft. - in.)	(ft. - in.)	(ft. - in.)	(ft. - in.)	(ft. - in.)	(ft. - in.)	(ft. - in.)	(ft. - in.)	(ft. - in.)	(ft. - in.)	(ft. - in.)	(ft. - in.)	(ft. - in.)	(ft. - in.)	(ft. - in.)	(ft. - in.)	(ft. - in.)	(ft. - in.)	(ft. - in.)
19.2	SPECIES AND GRADE																			
	Douglas Fir-Larch	SS	9-10	15-5	20-4	25-11	25-11	25-11	Note a	9-10	14-7	18-6	22-7	22-7	22-7	22-7	22-7	22-7	22-7	Note a
	Douglas Fir-Larch	#1	9-5	14-0	17-9	21-8	21-8	21-8	25-2	8-4	12-2	15-4	18-9	18-9	18-9	18-9	18-9	18-9	18-9	21-9
	Douglas Fir-Larch	#2	8-11	13-1	16-7	20-3	20-3	20-3	23-6	7-9	11-4	14-4	17-7	17-7	17-7	17-7	17-7	17-7	17-7	20-4
	Douglas Fir-Larch	#3	6-9	9-11	12-7	15-4	15-4	15-4	17-9	5-10	8-7	10-10	13-3	13-3	13-3	13-3	13-3	13-3	13-3	15-5
	Hem-Fir	SS	9-3	14-7	19-2	24-6	24-6	24-6	Note a	9-3	14-4	18-2	22-3	22-3	22-3	22-3	22-3	22-3	22-3	25-9
	Hem-Fir	#1	9-1	13-8	17-4	21-1	21-1	21-1	24-6	8-1	11-10	15-0	18-4	18-4	18-4	18-4	18-4	18-4	18-4	21-3
	Hem-Fir	#2	8-8	12-11	16-4	20-0	20-0	20-0	23-2	7-8	11-2	14-2	17-4	17-4	17-4	17-4	17-4	17-4	17-4	20-1
	Hem-Fir	#3	6-9	9-11	12-7	15-4	15-4	15-4	17-9	5-10	8-7	10-10	13-3	13-3	13-3	13-3	13-3	13-3	13-3	15-5
	Southern Pine	SS	9-8	15-2	19-11	25-5	25-5	25-5	Note a	9-8	15-2	19-11	25-5	25-5	25-5	25-5	25-5	25-5	25-5	Note a
	Southern Pine	#1	9-5	14-10	19-7	23-7	23-7	23-7	Note a	9-3	13-8	17-2	20-5	20-5	20-5	20-5	20-5	20-5	20-5	24-4
	Southern Pine	#2	9-3	13-9	17-9	21-2	21-2	21-2	24-10	8-4	11-11	15-4	18-4	18-4	18-4	18-4	18-4	18-4	18-4	21-6
	Southern Pine	#3	7-3	10-8	13-7	16-0	16-0	16-0	19-1	6-3	9-3	11-9	13-10	13-10	13-10	13-10	13-10	13-10	13-10	16-6
	Spruce-Pine-Fir	SS	9-1	14-3	18-9	23-11	23-11	23-11	Note a	9-1	13-7	17-2	21-0	21-0	21-0	21-0	21-0	21-0	21-0	24-4
	Spruce-Pine-Fir	#1	8-10	13-1	16-7	20-3	20-3	20-3	23-6	7-9	11-4	14-4	17-7	17-7	17-7	17-7	17-7	17-7	17-7	20-4
	Spruce-Pine-Fir	#2	8-10	13-1	16-7	20-3	20-3	20-3	23-6	7-9	11-4	14-4	17-7	17-7	17-7	17-7	17-7	17-7	17-7	20-4
	Spruce-Pine-Fir	#3	6-9	9-11	12-7	15-4	15-4	15-4	17-9	5-10	8-7	10-10	13-3	13-3	13-3	13-3	13-3	13-3	13-3	15-5
	Douglas Fir-Larch	SS	9-1	14-4	18-10	23-4	23-4	23-4	Note a	8-11	13-1	16-7	20-3	20-3	20-3	20-3	20-3	20-3	20-3	23-5
	Douglas Fir-Larch	#1	8-7	12-6	15-10	19-5	19-5	19-5	22-6	7-5	10-10	13-9	16-9	16-9	16-9	16-9	16-9	16-9	16-9	19-6
	Douglas Fir-Larch	#2	8-0	11-9	14-10	18-2	18-2	18-2	21-0	6-11	10-2	12-10	15-8	15-8	15-8	15-8	15-8	15-8	15-8	18-3
	Douglas Fir-Larch	#3	6-1	8-10	11-3	13-8	13-8	13-8	15-11	5-3	7-8	9-9	11-10	11-10	11-10	11-10	11-10	11-10	11-10	13-9
	Hem-Fir	SS	8-7	13-6	17-10	22-9	22-9	22-9	Note a	8-7	12-10	16-3	19-10	19-10	19-10	19-10	19-10	19-10	19-10	23-0
	Hem-Fir	#1	8-4	12-3	15-6	18-11	18-11	18-11	21-11	7-3	10-7	13-5	16-4	16-4	16-4	16-4	16-4	16-4	16-4	19-0
	Hem-Fir	#2	7-11	11-7	14-8	17-10	17-10	17-10	20-9	6-10	10-0	12-8	15-6	15-6	15-6	15-6	15-6	15-6	15-6	17-11
Hem-Fir	#3	6-1	8-10	11-3	13-8	13-8	13-8	15-11	5-3	7-8	9-9	11-10	11-10	11-10	11-10	11-10	11-10	11-10	13-9	
Southern Pine	SS	8-11	14-1	18-6	23-8	23-8	23-8	Note a	8-11	14-1	18-6	22-11	22-11	22-11	22-11	22-11	22-11	22-11	Note a	
Southern Pine	#1	8-9	13-9	17-9	21-1	21-1	21-1	25-2	8-3	12-3	15-4	18-3	18-3	18-3	18-3	18-3	18-3	18-3	21-9	
Southern Pine	#2	8-7	12-3	15-10	18-11	18-11	18-11	22-2	7-5	10-8	13-9	16-5	16-5	16-5	16-5	16-5	16-5	16-5	19-3	
Southern Pine	#3	6-5	9-6	12-1	14-4	14-4	14-4	17-1	5-7	8-3	10-6	12-5	12-5	12-5	12-5	12-5	12-5	12-5	14-9	
Spruce-Pine-Fir	SS	8-5	13-3	17-5	21-8	21-8	21-8	25-2	8-4	12-2	15-4	18-9	18-9	18-9	18-9	18-9	18-9	18-9	21-9	
Spruce-Pine-Fir	#1	8-0	11-9	14-10	18-2	18-2	18-2	21-0	6-11	10-2	12-10	15-8	15-8	15-8	15-8	15-8	15-8	15-8	18-3	
Spruce-Pine-Fir	#2	8-0	11-9	14-10	18-2	18-2	18-2	21-0	6-11	10-2	12-10	15-8	15-8	15-8	15-8	15-8	15-8	15-8	18-3	
Spruce-Pine-Fir	#3	6-1	8-10	11-3	13-8	13-8	13-8	15-11	5-3	7-8	9-9	11-10	11-10	11-10	11-10	11-10	11-10	11-10	13-9	

For SI: 1 inch = 25.4 mm, 1 foot = 304.8 mm, 1 pound per square foot = 47.9 N/m².
 a. Span exceeds 26 feet in length. Check sources for availability of lumber in lengths greater than 20 feet.

TABLE 2308.10.3(2)
RAFTER SPANS FOR COMMON LUMBER SPECIES
 (Roof Live Load = 20 pounds per square foot, Ceiling Not Attached to Rafters, $L/\Delta = 240$)

RAFTER SPACING (inches)	DEAD LOAD = 10 pounds per square foot				DEAD LOAD = 20 pounds per square foot				
	2 x 4	2 x 6	2 x 8	2 x 10	2 x 4	2 x 6	2 x 8	2 x 10	2 x 12
	(ft. - in.)	(ft. - in.)	(ft. - in.)	(ft. - in.)	(ft. - in.)	(ft. - in.)	(ft. - in.)	(ft. - in.)	(ft. - in.)
	Maximum rafter spans								
	(ft. - in.)	(ft. - in.)	(ft. - in.)	(ft. - in.)	(ft. - in.)	(ft. - in.)	(ft. - in.)	(ft. - in.)	(ft. - in.)
	10-5	16-4	21-7	Note a	10-5	16-4	21-7	Note a	Note a
	10-0	15-9	20-10	Note a	10-0	15-4	19-5	23-9	Note a
	9-10	15-6	20-5	25-8	9-10	14-4	18-2	22-3	25-9
	8-7	12-6	15-10	19-5	7-5	10-10	13-9	16-9	19-6
	9-10	15-6	20-5	Note a	9-10	15-6	20-5	Note a	Note a
	9-8	15-2	19-11	25-5	9-8	14-11	18-11	23-2	Note a
	9-2	14-5	19-0	24-3	9-2	14-2	17-11	21-11	25-5
	8-7	12-6	15-10	19-5	7-5	10-10	13-9	16-9	19-6
12	10-3	16-1	21-2	Note a	10-3	16-1	21-2	Note a	Note a
	10-0	15-9	20-10	Note a	10-0	15-9	20-10	25-10	Note a
	9-10	15-6	20-5	Note a	9-10	15-1	19-5	23-2	Note a
	9-1	13-6	17-2	20-3	7-11	11-8	14-10	17-6	20-11
	9-8	15-2	19-11	25-5	Note a	15-2	19-11	25-5	Note a
	9-5	14-9	19-6	24-10	9-5	14-4	18-2	22-3	25-9
	9-5	14-9	19-6	24-10	9-5	14-4	18-2	22-3	25-9
	8-7	12-6	15-10	19-5	7-5	10-10	13-9	16-9	19-6
	9-6	14-11	19-7	25-0	9-6	14-11	19-7	24-9	Note a
	9-1	14-4	18-11	23-9	9-1	13-3	16-10	20-7	23-10
	8-11	14-1	18-2	22-3	8-6	12-5	15-9	19-3	22-4
	7-5	10-10	13-9	16-9	6-5	9-5	11-11	14-6	16-10
	8-11	14-1	18-6	23-8	Note a	14-1	18-6	23-8	Note a
	8-9	13-9	18-1	23-1	8-9	12-11	16-5	20-0	23-3
	8-4	13-1	17-3	21-11	8-4	12-3	15-6	18-11	22-0
	7-5	10-10	13-9	16-9	6-5	9-5	11-11	14-6	16-10
	9-4	14-7	19-3	24-7	9-4	14-7	19-3	24-7	Note a
	9-1	14-4	18-11	24-1	9-1	14-4	18-10	22-4	Note a
	8-11	14-1	18-6	23-2	Note a	13-0	16-10	20-1	23-7
	7-11	11-8	14-10	17-6	6-10	10-1	12-10	15-2	18-1
	8-9	13-9	18-1	23-1	8-9	13-9	18-1	23-0	Note a
	8-7	13-5	17-9	22-3	8-6	12-5	15-9	19-3	22-4
	8-7	13-5	17-9	22-3	8-6	12-5	15-9	19-3	22-4
	7-5	10-10	13-9	16-9	6-5	9-5	11-11	14-6	16-10

(continued)

TABLE 2308.10.3(2)—continued
RAFTER SPANS FOR COMMON LUMBER SPECIES
 (Roof Live Load = 20 pounds per square foot, Ceiling Not Attached to Rafters, $L/\Delta = 240$)

RAFTER SPACING (inches)	DEAD LOAD = 10 pounds per square foot										DEAD LOAD = 20 pounds per square foot												
	2 x 4		2 x 6		2 x 8		2 x 10		2 x 12		2 x 4		2 x 6		2 x 8		2 x 10		2 x 12				
	(ft. - in.)	(ft. - in.)	(ft. - in.)	(ft. - in.)	(ft. - in.)	(ft. - in.)	(ft. - in.)	(ft. - in.)	(ft. - in.)	(ft. - in.)	(ft. - in.)	(ft. - in.)	(ft. - in.)	(ft. - in.)	(ft. - in.)	(ft. - in.)	(ft. - in.)	(ft. - in.)	(ft. - in.)	(ft. - in.)			
	Maximum rafter spans																						
	SPECIES AND GRADE																						
	Douglas Fir-Larch	SS	8-11	14-0	18-5	17-9	23-7	Note a	8-11	14-0	18-5	22-7	Note a	8-11	14-0	18-5	22-7	Note a	8-11	14-0	18-5	22-7	Note a
	Douglas Fir-Larch	#1	8-7	13-6	17-9	21-8	20-3	25-2	8-4	12-2	15-4	17-7	20-4	7-9	11-4	14-4	17-7	20-4	7-9	11-4	14-4	17-7	20-4
	Douglas Fir-Larch	#2	8-5	13-1	16-7	20-3	15-4	17-9	5-10	8-7	10-10	13-3	15-5	5-10	8-7	10-10	13-3	15-5	5-10	8-7	10-10	13-3	15-5
	Douglas Fir-Larch	#3	6-9	9-11	12-7	15-4	22-3	Note a	8-5	11-10	15-0	18-4	21-3	8-1	11-10	15-0	18-4	21-3	8-1	11-10	15-0	18-4	21-3
	Hem-Fir	SS	8-5	13-3	17-5	22-3	21-1	24-6	8-1	11-2	14-2	17-4	20-1	7-8	11-2	14-2	17-4	20-1	7-8	11-2	14-2	17-4	20-1
	Hem-Fir	#1	8-3	12-11	17-1	20-0	15-4	17-9	5-10	8-7	10-10	13-3	15-5	5-10	8-7	10-10	13-3	15-5	5-10	8-7	10-10	13-3	15-5
	Hem-Fir	#2	7-10	12-4	16-3	20-0	23-1	Note a	8-9	13-9	18-1	23-1	Note a	8-9	13-9	18-1	23-1	Note a	8-9	13-9	18-1	23-1	Note a
	Hem-Fir	#3	6-9	9-11	12-7	15-4	22-8	Note a	8-7	13-6	17-2	20-5	24-4	8-7	13-6	17-2	20-5	24-4	8-7	13-6	17-2	20-5	24-4
19.2	Southern Pine	SS	8-9	13-9	18-1	23-1	21-2	24-10	8-4	11-11	15-4	18-4	21-6	8-4	11-11	15-4	18-4	21-6	8-4	11-11	15-4	18-4	21-6
	Southern Pine	#1	8-7	13-6	17-9	22-8	16-0	19-1	6-3	9-3	11-9	13-10	16-6	6-3	9-3	11-9	13-10	16-6	6-3	9-3	11-9	13-10	16-6
	Southern Pine	#2	8-5	13-3	17-5	21-2	21-9	Note a	8-3	12-11	17-1	21-0	24-4	8-3	12-11	17-1	21-0	24-4	8-3	12-11	17-1	21-0	24-4
	Southern Pine	#3	7-3	10-8	13-7	16-0	20-3	23-6	7-9	11-4	14-4	17-7	20-4	7-9	11-4	14-4	17-7	20-4	7-9	11-4	14-4	17-7	20-4
	Spruce-Pine-Fir	SS	8-3	12-11	17-1	21-9	20-3	23-6	7-9	11-4	14-4	17-7	20-4	7-9	11-4	14-4	17-7	20-4	7-9	11-4	14-4	17-7	20-4
	Spruce-Pine-Fir	#1	8-1	12-8	16-7	20-3	23-6	23-6	7-9	11-4	14-4	17-7	20-4	7-9	11-4	14-4	17-7	20-4	7-9	11-4	14-4	17-7	20-4
	Spruce-Pine-Fir	#2	8-1	12-8	16-7	20-3	23-6	23-6	7-9	11-4	14-4	17-7	20-4	7-9	11-4	14-4	17-7	20-4	7-9	11-4	14-4	17-7	20-4
	Spruce-Pine-Fir	#3	6-9	9-11	12-7	15-4	15-4	17-9	5-10	8-7	10-10	13-3	15-5	5-10	8-7	10-10	13-3	15-5	5-10	8-7	10-10	13-3	15-5
	Douglas Fir-Larch	SS	8-3	13-0	17-2	21-10	21-10	Note a	8-3	13-0	16-7	20-3	23-5	8-3	13-0	16-7	20-3	23-5	8-3	13-0	16-7	20-3	23-5
	Douglas Fir-Larch	#1	8-0	12-6	15-10	19-5	19-5	22-6	7-5	10-10	13-9	16-9	19-6	7-5	10-10	13-9	16-9	19-6	7-5	10-10	13-9	16-9	19-6
	Douglas Fir-Larch	#2	7-10	11-9	14-10	18-2	18-2	21-0	6-11	10-2	12-10	15-8	18-3	6-11	10-2	12-10	15-8	18-3	6-11	10-2	12-10	15-8	18-3
	Douglas Fir-Larch	#3	6-1	8-10	11-3	13-8	13-8	15-11	5-3	7-8	9-9	11-10	13-9	5-3	7-8	9-9	11-10	13-9	5-3	7-8	9-9	11-10	13-9
	Hem-Fir	SS	7-10	12-3	16-2	20-8	20-8	25-1	7-10	12-3	16-2	19-10	23-0	7-10	12-3	16-2	19-10	23-0	7-10	12-3	16-2	19-10	23-0
	Hem-Fir	#1	7-8	12-0	15-6	18-11	18-11	21-11	7-3	10-7	13-5	16-4	19-0	7-3	10-7	13-5	16-4	19-0	7-3	10-7	13-5	16-4	19-0
	Hem-Fir	#2	7-3	11-5	14-8	17-10	17-10	20-9	6-10	10-0	12-8	15-6	17-11	6-10	10-0	12-8	15-6	17-11	6-10	10-0	12-8	15-6	17-11
	Hem-Fir	#3	6-1	8-10	11-3	13-8	13-8	15-11	5-3	7-8	9-9	11-10	13-9	5-3	7-8	9-9	11-10	13-9	5-3	7-8	9-9	11-10	13-9
24	Southern Pine	SS	8-1	12-9	16-10	21-6	21-6	Note a	8-1	12-9	16-10	21-6	Note a	8-1	12-9	16-10	21-6	Note a	8-1	12-9	16-10	21-6	Note a
	Southern Pine	#1	8-0	12-6	16-6	21-1	21-1	25-2	8-0	12-3	15-4	18-3	21-9	8-0	12-3	15-4	18-3	21-9	8-0	12-3	15-4	18-3	21-9
	Southern Pine	#2	7-10	12-3	15-10	18-11	18-11	22-2	7-5	10-8	13-9	16-5	19-3	7-5	10-8	13-9	16-5	19-3	7-5	10-8	13-9	16-5	19-3
	Southern Pine	#3	6-5	9-6	12-1	14-4	14-4	17-1	5-7	8-3	10-6	12-5	14-9	5-7	8-3	10-6	12-5	14-9	5-7	8-3	10-6	12-5	14-9
	Spruce-Pine-Fir	SS	7-8	12-0	15-10	20-2	20-2	24-7	7-8	12-0	15-4	18-9	21-9	7-8	12-0	15-4	18-9	21-9	7-8	12-0	15-4	18-9	21-9
	Spruce-Pine-Fir	#1	7-6	11-9	14-10	18-2	18-2	21-0	6-11	10-2	12-10	15-8	18-3	6-11	10-2	12-10	15-8	18-3	6-11	10-2	12-10	15-8	18-3
	Spruce-Pine-Fir	#2	7-6	11-9	14-10	18-2	18-2	21-0	6-11	10-2	12-10	15-8	18-3	6-11	10-2	12-10	15-8	18-3	6-11	10-2	12-10	15-8	18-3
	Spruce-Pine-Fir	#3	6-1	8-10	11-3	13-8	13-8	15-11	5-3	7-8	9-9	11-10	13-9	5-3	7-8	9-9	11-10	13-9	5-3	7-8	9-9	11-10	13-9

For SI: 1 inch = 25.4 mm, 1 foot = 304.8 mm, 1 pound per square foot = 47.9 N/m².
 a. Span exceeds 26 feet in length. Check sources for availability of lumber in lengths greater than 20 feet.

TABLE 2308.10.3(3)
RAFTER SPANS FOR COMMON LUMBER SPECIES
 (Ground Snow Load = 30 pounds per square foot, Ceiling Not Attached to Rafters, L/Δ = 180)

RAFTER SPACING (inches)	DEAD LOAD = 10 pounds per square foot										DEAD LOAD = 20 pounds per square foot									
	2 x 4		2 x 6		2 x 8		2 x 10		2 x 12		2 x 4		2 x 6		2 x 8		2 x 10		2 x 12	
	(ft. - in.)	(ft. - in.)	(ft. - in.)	(ft. - in.)	(ft. - in.)	(ft. - in.)	(ft. - in.)	(ft. - in.)	(ft. - in.)	(ft. - in.)	(ft. - in.)	(ft. - in.)	(ft. - in.)	(ft. - in.)	(ft. - in.)	(ft. - in.)	(ft. - in.)	(ft. - in.)	(ft. - in.)	(ft. - in.)
	SPECIES AND GRADE																			
	Douglas Fir-Larch	SS	10-0	15-9	20-9	20-9	Note a	Note a	Note a	Note a	10-0	15-9	20-1	20-1	20-1	20-1	24-6	24-6	Note a	Note a
	Douglas Fir-Larch	#1	9-8	14-9	18-8	18-8	22-9	22-9	22-9	9-0	13-2	16-8	16-8	16-8	16-8	16-8	20-4	20-4	23-7	23-7
	Douglas Fir-Larch	#2	9-5	13-9	17-5	17-5	21-4	21-4	21-4	8-5	12-4	15-7	15-7	15-7	15-7	19-1	19-1	22-1	22-1	22-1
	Douglas Fir-Larch	#3	7-1	10-5	13-2	13-2	16-1	16-1	16-1	6-4	9-4	11-9	11-9	11-9	11-9	14-5	14-5	16-8	16-8	16-8
	Hem-Fir	SS	9-6	14-10	19-7	19-7	25-0	25-0	25-0	9-6	14-10	19-7	19-7	19-7	24-1	24-1	24-1	Note a	Note a	Note a
	Hem-Fir	#1	9-3	14-4	18-2	18-2	22-2	22-2	22-2	8-9	12-10	16-3	16-3	16-3	19-10	19-10	23-0	23-0	23-0	23-0
	Hem-Fir	#2	8-10	13-7	17-2	17-2	21-0	21-0	21-0	8-4	12-2	15-4	15-4	15-4	18-9	18-9	21-9	21-9	21-9	21-9
	Hem-Fir	#3	7-1	10-5	13-2	13-2	16-1	16-1	16-1	6-4	9-4	11-9	11-9	11-9	14-5	14-5	16-8	16-8	16-8	16-8
12	Southern Pine	SS	9-10	15-6	20-5	20-5	Note a	Note a	Note a	9-10	15-6	20-5	20-5	20-5	Note a	Note a	Note a	Note a	Note a	Note a
	Southern Pine	#1	9-8	15-2	20-0	20-0	24-9	24-9	24-9	9-8	14-10	18-8	18-8	18-8	22-2	22-2	Note a	Note a	Note a	Note a
	Southern Pine	#2	9-6	14-5	18-8	18-8	22-3	22-3	22-3	9-0	12-11	16-8	16-8	16-8	19-11	19-11	23-4	23-4	23-4	23-4
	Southern Pine	#3	7-7	11-2	14-3	14-3	16-10	16-10	16-10	6-9	10-0	12-9	12-9	12-9	15-1	15-1	17-11	17-11	17-11	17-11
	Spruce-Pine-Fir	SS	9-3	14-7	19-2	19-2	24-6	24-6	24-6	9-3	14-7	18-8	18-8	18-8	22-9	22-9	Note a	Note a	Note a	Note a
	Spruce-Pine-Fir	#1	9-1	13-9	17-5	17-5	21-4	21-4	21-4	8-5	12-4	15-7	15-7	15-7	19-1	19-1	22-1	22-1	22-1	22-1
	Spruce-Pine-Fir	#2	9-1	13-9	17-5	17-5	21-4	21-4	21-4	8-5	12-4	15-7	15-7	15-7	19-1	19-1	22-1	22-1	22-1	22-1
	Spruce-Pine-Fir	#3	7-1	10-5	13-2	13-2	16-1	16-1	16-1	6-4	9-4	11-9	11-9	11-9	14-5	14-5	16-8	16-8	16-8	16-8
	Douglas Fir-Larch	SS	9-1	14-4	18-10	18-10	23-9	23-9	23-9	9-1	13-9	17-5	17-5	17-5	21-3	21-3	24-8	24-8	24-8	24-8
	Douglas Fir-Larch	#1	8-9	12-9	16-2	16-2	19-9	19-9	19-9	7-10	11-5	14-5	14-5	14-5	17-8	17-8	20-5	20-5	20-5	20-5
	Douglas Fir-Larch	#2	8-2	11-11	15-1	15-1	18-5	18-5	18-5	7-3	10-8	13-6	13-6	13-6	16-6	16-6	19-2	19-2	19-2	19-2
	Douglas Fir-Larch	#3	6-2	9-0	11-5	11-5	13-11	13-11	13-11	5-6	8-1	10-3	10-3	10-3	12-6	12-6	14-6	14-6	14-6	14-6
	Hem-Fir	SS	8-7	13-6	17-10	17-10	22-9	22-9	22-9	8-7	13-6	17-1	17-1	17-1	20-10	20-10	24-2	24-2	24-2	24-2
	Hem-Fir	#1	8-5	12-5	15-9	15-9	19-3	19-3	19-3	7-7	11-1	14-1	14-1	14-1	17-2	17-2	19-11	19-11	19-11	19-11
	Hem-Fir	#2	8-0	11-9	14-11	14-11	18-2	18-2	18-2	7-2	10-6	13-4	13-4	13-4	16-3	16-3	18-10	18-10	18-10	18-10
	Hem-Fir	#3	6-2	9-0	11-5	11-5	13-11	13-11	13-11	5-6	8-1	10-3	10-3	10-3	12-6	12-6	14-6	14-6	14-6	14-6
16	Southern Pine	SS	8-11	14-1	18-6	18-6	23-8	23-8	23-8	8-11	14-1	18-6	18-6	18-6	23-8	23-8	Note a	Note a	Note a	Note a
	Southern Pine	#1	8-9	13-9	18-1	18-1	21-5	21-5	21-5	8-8	12-10	16-2	16-2	16-2	19-2	19-2	22-10	22-10	22-10	22-10
	Southern Pine	#2	8-7	12-6	16-2	16-2	19-3	19-3	19-3	7-10	11-2	14-5	14-5	14-5	17-3	17-3	20-2	20-2	20-2	20-2
	Southern Pine	#3	6-7	9-8	12-4	12-4	14-7	14-7	14-7	5-10	8-8	11-0	11-0	11-0	13-0	13-0	15-6	15-6	15-6	15-6
	Spruce-Pine-Fir	SS	8-5	13-3	17-5	17-5	22-1	22-1	22-1	8-5	12-9	16-2	16-2	16-2	19-9	19-9	22-10	22-10	22-10	22-10
	Spruce-Pine-Fir	#1	8-2	11-11	15-1	15-1	18-5	18-5	18-5	7-3	10-8	13-6	13-6	13-6	16-6	16-6	19-2	19-2	19-2	19-2
	Spruce-Pine-Fir	#2	8-2	11-11	15-1	15-1	18-5	18-5	18-5	7-3	10-8	13-6	13-6	13-6	16-6	16-6	19-2	19-2	19-2	19-2
	Spruce-Pine-Fir	#3	6-2	9-0	11-5	11-5	13-11	13-11	13-11	5-6	8-1	10-3	10-3	10-3	12-6	12-6	14-6	14-6	14-6	14-6

(continued)

TABLE 2308.10.3(3)—continued
RAFTER SPANS FOR COMMON LUMBER SPECIES
 (Ground Snow Load = 30 pounds per square foot, Ceiling Not Attached to Rafters, L/Δ = 180)

RAFTER SPACING (inches)	DEAD LOAD = 10 pounds per square foot										DEAD LOAD = 20 pounds per square foot															
	2 x 4		2 x 6		2 x 8		2 x 10		2 x 12		2 x 4		2 x 6		2 x 8		2 x 10		2 x 12							
	(ft. - in.)	(ft. - in.)	(ft. - in.)	(ft. - in.)	(ft. - in.)	(ft. - in.)	(ft. - in.)	(ft. - in.)	(ft. - in.)	(ft. - in.)	(ft. - in.)	(ft. - in.)	(ft. - in.)	(ft. - in.)	(ft. - in.)	(ft. - in.)	(ft. - in.)	(ft. - in.)	(ft. - in.)	(ft. - in.)						
	SPECIES AND GRADE																									
	Douglas Fir-Larch	SS	8-7	13-6	17-9	14-9	18-0	21-8	25-2	8-7	12-6	15-10	19-5	22-6	Douglas Fir-Larch	#1	7-11	11-8	14-9	18-0	20-11	7-1	10-5	13-2	16-1	18-8
	Douglas Fir-Larch	#2	7-5	10-11	13-9	16-10	19-6	24-8	28-1	6-8	9-9	12-4	15-1	17-6	Douglas Fir-Larch	#3	5-7	8-3	10-5	12-9	14-9	5-0	7-4	9-4	11-5	13-2
	Hem-Fir	SS	8-1	12-9	16-9	21-4	24-8	28-1	31-5	8-1	12-4	15-7	19-1	22-1	Hem-Fir	#1	7-9	11-4	14-4	17-7	20-4	6-11	10-2	12-10	15-8	18-2
	Hem-Fir	#2	7-4	10-9	13-7	16-7	19-3	22-3	25-3	6-7	9-7	12-2	14-10	17-3	Hem-Fir	#3	5-7	8-3	10-5	12-9	14-9	5-0	7-4	9-4	11-5	13-2
19.2	Southern Pine	SS	8-5	13-3	17-5	22-3	Note a	26-1	29-1	8-5	13-3	17-5	22-0	25-9	Southern Pine	#1	8-3	13-0	16-6	19-7	23-4	7-11	11-9	14-9	17-6	20-11
	Southern Pine	#2	7-11	11-5	14-9	17-7	20-7	23-7	26-7	7-1	10-2	13-2	15-9	18-5	Southern Pine	#3	6-0	8-10	11-3	13-4	15-10	5-4	7-11	10-1	11-11	14-2
	Spruce-Pine-Fir	SS	7-11	12-5	16-5	20-2	23-4	26-6	29-8	7-11	11-8	14-9	18-0	21-1	Spruce-Pine-Fir	#1	7-5	10-11	13-9	16-10	19-6	6-8	9-9	12-4	15-1	17-6
	Spruce-Pine-Fir	#2	7-5	10-11	13-9	16-10	19-6	22-6	25-6	6-8	9-9	12-4	15-1	17-6	Spruce-Pine-Fir	#3	5-7	8-3	10-5	12-9	14-9	5-0	7-4	9-4	11-5	13-2
	Douglas Fir-Larch	SS	7-11	12-6	15-10	19-5	22-6	25-6	28-6	7-8	11-3	14-2	17-4	20-1	Douglas Fir-Larch	#1	7-1	10-5	13-2	16-1	18-8	6-4	9-4	11-9	14-5	16-8
	Douglas Fir-Larch	#2	6-8	9-9	12-4	15-1	17-6	20-1	22-6	5-11	8-8	11-0	13-6	15-7	Douglas Fir-Larch	#3	5-0	7-4	9-4	11-5	13-2	4-6	6-7	8-4	10-2	11-10
	Hem-Fir	SS	7-6	11-10	15-7	19-1	22-1	25-1	28-1	7-6	11-0	13-11	17-0	19-9	Hem-Fir	#1	6-11	10-2	12-10	15-8	18-2	6-2	9-1	11-6	14-0	16-3
	Hem-Fir	#2	6-7	9-7	12-2	14-10	17-3	20-6	23-9	5-10	8-7	10-10	13-3	15-5	Hem-Fir	#3	5-0	7-4	9-4	11-5	13-2	4-6	6-7	8-4	10-2	11-10
24	Southern Pine	SS	7-10	12-3	16-2	20-8	25-1	29-4	33-7	7-10	12-3	16-2	19-8	23-0	Southern Pine	#1	7-8	11-9	14-9	17-6	20-11	7-1	10-6	13-2	15-8	18-8
	Southern Pine	#2	7-1	10-2	13-2	15-9	18-5	21-1	23-7	6-4	9-2	11-9	14-1	16-6	Southern Pine	#3	5-4	7-11	10-1	11-11	14-2	4-9	7-1	9-0	10-8	12-8
	Spruce-Pine-Fir	SS	7-4	11-7	14-9	18-0	20-11	22-1	24-1	7-1	10-5	13-2	16-1	18-8	Spruce-Pine-Fir	#1	6-8	9-9	12-4	15-1	17-6	5-11	8-8	11-0	13-6	15-7
	Spruce-Pine-Fir	#2	6-8	9-9	12-4	15-1	17-6	20-1	22-1	5-11	8-8	11-0	13-6	15-7	Spruce-Pine-Fir	#3	5-0	7-4	9-4	11-5	13-2	4-6	6-7	8-4	10-2	11-10

For SI: 1 inch = 25.4 mm, 1 foot = 304.8 mm, 1 pound per square foot = 47.9 N/m².
 a. Span exceeds 26 feet in length. Check sources for availability of lumber in lengths greater than 20 feet.

TABLE 2308.10.3(4)
RAFTER SPANS FOR COMMON LUMBER SPECIES
 (Ground Snow Load = 50 pounds per square foot, Ceiling Not Attached to Rafters, L/Δ = 180)

RAFTER SPACING (inches)	DEAD LOAD = 10 pounds per square foot										DEAD LOAD = 20 pounds per square foot									
	2 x 4		2 x 6		2 x 8		2 x 10		2 x 12		2 x 4		2 x 6		2 x 8		2 x 10		2 x 12	
	(ft. - in.)	(ft. - in.)	(ft. - in.)	(ft. - in.)	(ft. - in.)	(ft. - in.)	(ft. - in.)	(ft. - in.)	(ft. - in.)	(ft. - in.)	(ft. - in.)	(ft. - in.)	(ft. - in.)	(ft. - in.)	(ft. - in.)	(ft. - in.)	(ft. - in.)	(ft. - in.)	(ft. - in.)	(ft. - in.)
	Maximum rafter spans																			
	(ft. - in.)	(ft. - in.)	(ft. - in.)	(ft. - in.)	(ft. - in.)	(ft. - in.)	(ft. - in.)	(ft. - in.)	(ft. - in.)	(ft. - in.)	(ft. - in.)	(ft. - in.)	(ft. - in.)	(ft. - in.)	(ft. - in.)	(ft. - in.)	(ft. - in.)	(ft. - in.)	(ft. - in.)	(ft. - in.)
	8-5	13-3	17-6	22-4	26-0	8-5	13-3	17-0	20-9	24-10	8-5	13-3	17-0	20-9	24-10	8-5	13-3	17-0	20-9	24-10
	8-2	12-0	15-3	18-7	21-7	7-7	11-2	14-1	17-3	20-0	7-1	10-5	13-2	16-1	18-8	5-5	7-10	10-0	12-2	14-1
	7-8	11-3	14-3	17-5	20-2	7-1	10-5	13-2	16-1	18-8	5-5	7-10	10-0	12-2	14-1	8-0	12-6	16-6	20-4	23-7
	5-10	8-6	10-9	13-2	15-3	8-0	12-6	16-6	20-4	23-7	7-5	10-10	13-9	16-9	19-5	7-5	10-10	13-9	16-9	19-5
	8-0	12-6	16-6	21-1	25-6	7-5	10-10	13-9	16-9	19-5	7-0	10-3	13-0	15-10	18-5	7-0	10-3	13-0	15-10	18-5
	7-10	11-9	14-10	18-1	21-0	7-0	10-3	13-0	15-10	18-5	5-5	7-10	10-0	12-2	14-1	Note a	13-0	17-2	21-11	Note a
	7-5	11-1	14-0	17-2	19-11	8-4	12-6	15-9	18-9	22-4	8-2	12-6	15-9	18-9	22-4	8-2	12-6	15-9	18-9	22-4
	5-10	8-6	10-9	13-2	15-3	7-7	10-11	14-1	16-10	19-9	7-7	10-11	14-1	16-10	19-9	6-2	9-2	11-8	13-9	16-4
	8-4	13-0	17-2	21-11	Note a	8-4	13-0	17-2	21-11	Note a	8-4	13-0	17-2	21-11	Note a	7-10	12-3	15-9	19-3	22-4
	8-2	12-10	16-10	20-3	24-1	8-2	12-6	15-9	18-9	22-4	7-10	12-3	15-9	19-3	22-4	7-10	12-3	15-9	19-3	22-4
	8-0	11-9	15-3	18-2	21-3	7-7	10-11	14-1	16-10	19-9	7-1	10-5	13-2	16-1	18-8	7-1	10-5	13-2	16-1	18-8
	6-2	9-2	11-8	13-9	16-4	5-9	8-5	10-9	12-9	15-2	7-1	10-5	13-2	16-1	18-8	7-1	10-5	13-2	16-1	18-8
	7-10	12-3	16-2	20-8	24-1	7-10	12-3	15-9	19-3	22-4	7-1	10-5	13-2	16-1	18-8	7-1	10-5	13-2	16-1	18-8
	7-8	11-3	14-3	17-5	20-2	7-1	10-5	13-2	16-1	18-8	7-1	10-5	13-2	16-1	18-8	7-1	10-5	13-2	16-1	18-8
	7-8	11-3	14-3	17-5	20-2	7-1	10-5	13-2	16-1	18-8	7-1	10-5	13-2	16-1	18-8	7-1	10-5	13-2	16-1	18-8
	5-10	8-6	10-9	13-2	15-3	5-5	7-10	10-0	12-2	14-1	5-5	7-10	10-0	12-2	14-1	5-5	7-10	10-0	12-2	14-1
	7-8	12-1	15-10	19-5	22-6	7-8	11-7	14-8	17-11	20-10	7-8	11-7	14-8	17-11	20-10	7-8	11-7	14-8	17-11	20-10
	7-1	10-5	13-2	16-1	18-8	6-7	9-8	12-2	14-11	17-3	6-7	9-8	12-2	14-11	17-3	6-7	9-8	12-2	14-11	17-3
	6-8	9-9	12-4	15-1	17-6	6-2	9-0	11-5	13-11	16-2	6-2	9-0	11-5	13-11	16-2	6-2	9-0	11-5	13-11	16-2
	5-0	7-4	9-4	11-5	13-2	4-8	6-10	8-8	10-6	12-3	4-8	6-10	8-8	10-6	12-3	4-8	6-10	8-8	10-6	12-3
	7-3	11-5	15-0	19-1	22-1	7-3	11-5	14-5	17-8	20-5	7-3	11-5	14-5	17-8	20-5	7-3	11-5	14-5	17-8	20-5
	6-11	10-2	12-10	15-8	18-2	6-5	9-5	11-11	14-6	16-10	6-5	9-5	11-11	14-6	16-10	6-5	9-5	11-11	14-6	16-10
	6-7	9-7	12-2	14-10	17-3	6-1	8-11	11-3	13-9	15-11	6-1	8-11	11-3	13-9	15-11	6-1	8-11	11-3	13-9	15-11
	5-0	7-4	9-4	11-5	13-2	4-8	6-10	8-8	10-6	12-3	4-8	6-10	8-8	10-6	12-3	4-8	6-10	8-8	10-6	12-3
	7-6	11-10	15-7	19-11	24-3	7-6	11-10	15-7	19-11	23-10	7-6	11-10	15-7	19-11	23-10	7-6	11-10	15-7	19-11	23-10
	7-5	11-7	14-9	17-6	20-11	7-4	10-10	13-8	16-2	19-4	7-4	10-10	13-8	16-2	19-4	7-4	10-10	13-8	16-2	19-4
	7-1	10-2	13-2	15-9	18-5	6-7	9-5	12-2	14-7	17-1	6-7	9-5	12-2	14-7	17-1	6-7	9-5	12-2	14-7	17-1
	5-4	7-11	10-1	11-11	14-2	4-11	7-4	9-4	11-0	13-1	4-11	7-4	9-4	11-0	13-1	4-11	7-4	9-4	11-0	13-1
	7-1	11-2	14-8	18-0	20-11	7-1	10-9	13-8	16-8	19-4	7-1	10-9	13-8	16-8	19-4	7-1	10-9	13-8	16-8	19-4
	6-8	9-9	12-4	15-1	17-6	6-2	9-0	11-5	13-11	16-2	6-2	9-0	11-5	13-11	16-2	6-2	9-0	11-5	13-11	16-2
	6-8	9-9	12-4	15-1	17-6	6-2	9-0	11-5	13-11	16-2	6-2	9-0	11-5	13-11	16-2	6-2	9-0	11-5	13-11	16-2
	5-0	7-4	9-4	11-5	13-2	4-8	6-10	8-8	10-6	12-3	4-8	6-10	8-8	10-6	12-3	4-8	6-10	8-8	10-6	12-3

(continued)

TABLE 2308.10.3(4)—continued
 RAFTER SPANS FOR COMMON LUMBER SPECIES
 (Ground Snow Load = 50 pounds per square foot, Ceiling Not Attached to Rafters, L/Δ = 180)

RAFTER SPACING (inches)	SPECIES AND GRADE	DEAD LOAD = 10 pounds per square foot					DEAD LOAD = 20 pounds per square foot					
		2 x 4	2 x 6	2 x 8	2 x 10	2 x 12	2 x 4	2 x 6	2 x 8	2 x 10	2 x 12	
		(ft. - in.)	(ft. - in.)	(ft. - in.)	(ft. - in.)	(ft. - in.)	(ft. - in.)	(ft. - in.)	(ft. - in.)	(ft. - in.)	(ft. - in.)	
19.2	Douglas Fir-Larch	SS	7-3	11-4	14-6	17-8	20-6	7-3	10-7	13-5	16-5	19-0
	Douglas Fir-Larch	#1	6-6	9-6	12-0	14-8	17-1	6-0	8-10	11-2	13-7	15-9
	Douglas Fir-Larch	#2	6-1	8-11	11-3	13-9	15-11	5-7	8-3	10-5	12-9	14-9
	Douglas Fir-Larch	#3	4-7	6-9	8-6	10-5	12-1	4-3	6-3	7-11	9-7	11-2
	Hem-Fir	SS	6-10	10-9	14-2	17-5	20-2	6-10	10-5	13-2	16-1	18-8
	Hem-Fir	#1	6-4	9-3	11-9	14-4	16-7	5-10	8-7	10-10	13-3	15-5
	Hem-Fir	#2	6-0	8-9	11-1	13-7	15-9	5-7	8-1	10-3	12-7	14-7
	Hem-Fir	#3	4-7	6-9	8-6	10-5	12-1	4-3	6-3	7-11	9-7	11-2
	Southern Pine	SS	7-1	11-2	14-8	18-9	22-10	7-1	11-2	14-8	18-7	21-9
	Southern Pine	#1	7-0	10-8	13-5	16-0	19-1	6-8	9-11	12-5	14-10	17-8
	Southern Pine	#2	6-6	9-4	12-0	14-4	16-10	6-0	8-8	11-2	13-4	15-7
	Southern Pine	#3	4-11	7-3	9-2	10-10	12-11	4-6	6-8	8-6	10-1	12-0
	Spruce-Pine-Fir	SS	6-8	10-6	13-5	16-5	19-1	6-8	9-10	12-5	15-3	17-8
	Spruce-Pine-Fir	#1	6-1	8-11	11-3	13-9	15-11	5-7	8-3	10-5	12-9	14-9
	Spruce-Pine-Fir	#2	6-1	8-11	11-3	13-9	15-11	5-7	8-3	10-5	12-9	14-9
	Spruce-Pine-Fir	#3	4-7	6-9	8-6	10-5	12-1	4-3	6-3	7-11	9-7	11-2
	Douglas Fir-Larch	SS	6-8	10-3	13-0	15-10	18-4	6-6	9-6	12-0	14-8	17-0
	Douglas Fir-Larch	#1	5-10	8-6	10-9	13-2	15-3	5-5	7-10	10-0	12-2	14-1
	Douglas Fir-Larch	#2	5-5	7-11	10-1	12-4	14-3	5-0	7-4	9-4	11-5	13-2
	Douglas Fir-Larch	#3	4-1	6-0	7-7	9-4	10-9	3-10	5-7	7-1	8-7	10-0
	Hem-Fir	SS	6-4	9-11	12-9	15-7	18-0	6-4	9-4	11-9	14-5	16-8
	Hem-Fir	#1	5-8	8-3	10-6	12-10	14-10	5-3	7-8	9-9	11-10	13-9
	Hem-Fir	#2	5-4	7-10	9-11	12-1	14-1	4-11	7-3	9-2	11-3	13-0
	Hem-Fir	#3	4-1	6-0	7-7	9-4	10-9	3-10	5-7	7-1	8-7	10-0
Southern Pine	SS	6-7	10-4	13-8	17-5	21-0	6-7	10-4	13-8	16-7	19-5	
Southern Pine	#1	6-5	9-7	12-0	14-4	17-1	6-0	8-10	11-2	13-3	15-9	
Southern Pine	#2	5-10	8-4	10-9	12-10	15-1	5-5	7-9	10-0	11-11	13-11	
Southern Pine	#3	4-4	6-5	8-3	9-9	11-7	4-1	6-0	7-7	9-0	10-8	
Spruce-Pine-Fir	SS	6-2	9-6	12-0	14-8	17-1	6-0	8-10	11-2	13-7	15-9	
Spruce-Pine-Fir	#1	5-5	7-11	10-1	12-4	14-3	5-0	7-4	9-4	11-5	13-2	
Spruce-Pine-Fir	#2	5-5	7-11	10-1	12-4	14-3	5-0	7-4	9-4	11-5	13-2	
Spruce-Pine-Fir	#3	4-1	6-0	7-7	9-4	10-9	3-10	5-7	7-1	8-7	10-0	
24	Douglas Fir-Larch	SS	6-4	9-11	12-9	15-7	18-0	6-4	9-4	11-9	14-5	16-8
	Douglas Fir-Larch	#1	5-8	8-3	10-6	12-10	14-10	5-3	7-8	9-9	11-10	13-9
	Douglas Fir-Larch	#2	5-4	7-10	9-11	12-1	14-1	4-11	7-3	9-2	11-3	13-0
	Douglas Fir-Larch	#3	4-1	6-0	7-7	9-4	10-9	3-10	5-7	7-1	8-7	10-0
	Southern Pine	SS	6-7	10-4	13-8	17-5	21-0	6-7	10-4	13-8	16-7	19-5
	Southern Pine	#1	6-5	9-7	12-0	14-4	17-1	6-0	8-10	11-2	13-3	15-9
	Southern Pine	#2	5-10	8-4	10-9	12-10	15-1	5-5	7-9	10-0	11-11	13-11
	Southern Pine	#3	4-4	6-5	8-3	9-9	11-7	4-1	6-0	7-7	9-0	10-8
	Spruce-Pine-Fir	SS	6-2	9-6	12-0	14-8	17-1	6-0	8-10	11-2	13-7	15-9
	Spruce-Pine-Fir	#1	5-5	7-11	10-1	12-4	14-3	5-0	7-4	9-4	11-5	13-2
	Spruce-Pine-Fir	#2	5-5	7-11	10-1	12-4	14-3	5-0	7-4	9-4	11-5	13-2
	Spruce-Pine-Fir	#3	4-1	6-0	7-7	9-4	10-9	3-10	5-7	7-1	8-7	10-0

For SI: 1 inch = 25.4 mm, 1 foot = 304.8 mm, 1 pound per square foot = 47.9 N/m².
 a. Span exceeds 26 feet in length. Check sources for availability of lumber in lengths greater than 20 feet.

TABLE 2308.10.3(5)
RAFTER SPANS FOR COMMON LUMBER SPECIES
 (Ground Snow Load = 30 pounds per square foot, Ceiling Attached to Rafters, $L/\Delta = 240$)

RAFTER SPACING (inches)	DEAD LOAD = 10 pounds per square foot										DEAD LOAD = 20 pounds per square foot									
	2 x 4		2 x 6		2 x 8		2 x 10		2 x 12		2 x 4		2 x 6		2 x 8		2 x 10		2 x 12	
	(ft. - in.)	(ft. - in.)	(ft. - in.)	(ft. - in.)	(ft. - in.)	(ft. - in.)	(ft. - in.)	(ft. - in.)	(ft. - in.)	(ft. - in.)	(ft. - in.)	(ft. - in.)	(ft. - in.)	(ft. - in.)	(ft. - in.)	(ft. - in.)	(ft. - in.)	(ft. - in.)	(ft. - in.)	(ft. - in.)
	SPECIES AND GRADE																			
	Douglas Fir-Larch	SS	9-1	14-4	18-10	24-1	24-1	24-1	24-1	24-1	9-1	14-4	18-10	24-1	24-1	24-1	24-1	24-1	24-1	24-1
	Douglas Fir-Larch	#1	8-9	13-9	18-2	22-9	22-9	22-9	22-9	22-9	8-9	13-2	16-8	20-4	20-4	20-4	20-4	20-4	20-4	23-7
	Douglas Fir-Larch	#2	8-7	13-6	17-5	21-4	21-4	21-4	21-4	21-4	8-5	12-4	15-7	19-1	19-1	19-1	19-1	19-1	19-1	22-1
	Douglas Fir-Larch	#3	7-1	10-5	13-2	16-1	16-1	16-1	16-1	16-1	6-4	9-4	11-9	14-5	14-5	14-5	14-5	14-5	14-5	16-8
	Hem-Fir	SS	8-7	13-6	17-10	22-9	22-9	22-9	22-9	22-9	8-7	13-6	17-10	22-9	22-9	22-9	22-9	22-9	22-9	Note a
	Hem-Fir	#1	8-5	13-3	17-5	22-2	22-2	22-2	22-2	22-2	8-5	12-10	16-3	19-10	19-10	19-10	19-10	19-10	19-10	23-0
	Hem-Fir	#2	8-0	12-7	16-7	21-0	21-0	21-0	21-0	21-0	8-0	12-2	15-4	18-9	18-9	18-9	18-9	18-9	18-9	21-9
	Hem-Fir	#3	7-1	10-5	13-2	16-1	16-1	16-1	16-1	16-1	6-4	9-4	11-9	14-5	14-5	14-5	14-5	14-5	14-5	16-8
12	Southern Pine	SS	8-11	14-1	18-6	23-8	23-8	23-8	23-8	23-8	8-11	14-1	18-6	23-8	23-8	23-8	23-8	23-8	23-8	Note a
	Southern Pine	#1	8-9	13-9	18-2	23-2	23-2	23-2	23-2	23-2	8-9	13-9	18-2	22-2	22-2	22-2	22-2	22-2	22-2	Note a
	Southern Pine	#2	8-7	13-6	17-10	22-3	22-3	22-3	22-3	22-3	8-7	12-11	16-8	19-11	19-11	19-11	19-11	19-11	19-11	23-4
	Southern Pine	#3	7-7	11-2	14-3	16-10	16-10	16-10	16-10	16-10	6-9	10-0	12-9	15-1	15-1	15-1	15-1	15-1	15-1	17-11
	Spruce-Pine-Fir	SS	8-5	13-3	17-5	22-3	22-3	22-3	22-3	22-3	8-5	13-3	17-5	22-3	22-3	22-3	22-3	22-3	22-3	Note a
	Spruce-Pine-Fir	#1	8-3	12-11	17-0	21-4	21-4	21-4	21-4	21-4	8-3	12-4	15-7	19-1	19-1	19-1	19-1	19-1	19-1	22-1
	Spruce-Pine-Fir	#2	8-3	12-11	17-0	21-4	21-4	21-4	21-4	21-4	8-3	12-4	15-7	19-1	19-1	19-1	19-1	19-1	19-1	22-1
	Spruce-Pine-Fir	#3	7-1	10-5	13-2	16-1	16-1	16-1	16-1	16-1	6-4	9-4	11-9	14-5	14-5	14-5	14-5	14-5	14-5	16-8
	Douglas Fir-Larch	SS	8-3	13-0	17-2	21-10	21-10	21-10	21-10	21-10	8-3	13-0	17-2	21-3	21-3	21-3	21-3	21-3	21-3	24-8
	Douglas Fir-Larch	#1	8-0	12-6	16-2	19-9	19-9	19-9	19-9	19-9	7-10	11-5	14-5	17-8	17-8	17-8	17-8	17-8	17-8	20-5
	Douglas Fir-Larch	#2	7-10	11-11	15-1	18-5	18-5	18-5	18-5	18-5	7-3	10-8	13-6	16-6	16-6	16-6	16-6	16-6	16-6	19-2
	Douglas Fir-Larch	#3	6-2	9-0	11-5	13-11	13-11	13-11	13-11	13-11	5-6	8-1	10-3	12-6	12-6	12-6	12-6	12-6	12-6	14-6
	Hem-Fir	SS	7-10	12-3	16-2	20-8	20-8	20-8	20-8	20-8	7-10	12-3	16-2	20-8	20-8	20-8	20-8	20-8	20-8	24-2
	Hem-Fir	#1	7-8	12-0	15-9	19-3	19-3	19-3	19-3	19-3	7-7	11-1	14-1	17-2	17-2	17-2	17-2	17-2	17-2	19-11
	Hem-Fir	#2	7-3	11-5	14-11	18-2	18-2	18-2	18-2	18-2	7-2	10-6	13-4	16-3	16-3	16-3	16-3	16-3	16-3	18-10
	Hem-Fir	#3	6-2	9-0	11-5	13-11	13-11	13-11	13-11	13-11	5-6	8-1	10-3	12-6	12-6	12-6	12-6	12-6	12-6	14-6
16	Southern Pine	SS	8-1	12-9	16-10	21-6	21-6	21-6	21-6	21-6	8-1	12-9	16-10	21-6	21-6	21-6	21-6	21-6	21-6	Note a
	Southern Pine	#1	8-0	12-6	16-6	21-1	21-1	21-1	21-1	21-1	8-0	12-6	16-2	19-2	19-2	19-2	19-2	19-2	19-2	22-10
	Southern Pine	#2	7-10	12-3	16-2	19-3	19-3	19-3	19-3	19-3	7-10	11-2	14-5	17-3	17-3	17-3	17-3	17-3	17-3	20-2
	Southern Pine	#3	6-7	9-8	12-4	14-7	14-7	14-7	14-7	14-7	5-10	8-8	11-0	13-0	13-0	13-0	13-0	13-0	13-0	15-6
	Spruce-Pine-Fir	SS	7-8	12-0	15-10	20-2	20-2	20-2	20-2	20-2	7-8	12-0	15-10	19-9	19-9	19-9	19-9	19-9	19-9	22-10
	Spruce-Pine-Fir	#1	7-6	11-9	15-1	18-5	18-5	18-5	18-5	18-5	7-3	10-8	13-6	16-6	16-6	16-6	16-6	16-6	16-6	19-2
	Spruce-Pine-Fir	#2	7-6	11-9	15-1	18-5	18-5	18-5	18-5	18-5	7-3	10-8	13-6	16-6	16-6	16-6	16-6	16-6	16-6	19-2
	Spruce-Pine-Fir	#3	6-2	9-0	11-5	13-11	13-11	13-11	13-11	13-11	5-6	8-1	10-3	12-6	12-6	12-6	12-6	12-6	12-6	14-6

(continued)

TABLE 2308.10.3(5)—continued
RAFTER SPANS FOR COMMON LUMBER SPECIES
 (Ground Snow Load = 30 pounds per square foot, Ceiling Attached to Rafters, $L/\Delta = 240$)

RAFTER SPACING (inches)	SPECIES AND GRADE	DEAD LOAD = 10 pounds per square foot						DEAD LOAD = 20 pounds per square foot					
		2 x 4	2 x 6	2 x 8	2 x 10	2 x 12	2 x 4	2 x 6	2 x 8	2 x 10	2 x 12		
		(ft. - in.)	(ft. - in.)	(ft. - in.)	(ft. - in.)	(ft. - in.)	(ft. - in.)	(ft. - in.)	(ft. - in.)	(ft. - in.)	(ft. - in.)		
19.2	Douglas Fir-Larch	SS	7-9	12-3	16-1	20-7	25-0	7-9	12-3	15-10	19-5	22-6	
	Douglas Fir-Larch	#1	7-6	11-8	14-9	18-0	20-11	7-1	10-5	13-2	16-1	18-8	
	Douglas Fir-Larch	#2	7-4	10-11	13-9	16-10	19-6	6-8	9-9	12-4	15-1	17-6	
	Douglas Fir-Larch	#3	5-7	8-3	10-5	12-9	14-9	5-0	7-4	9-4	11-5	13-2	
	Hem-Fir	SS	7-4	11-7	15-3	19-5	23-7	7-4	11-7	15-3	19-1	22-1	
	Hem-Fir	#1	7-2	11-4	14-4	17-7	20-4	6-11	6-7	12-2	14-10	17-3	
	Hem-Fir	#2	6-10	10-9	13-7	16-7	19-3	6-7	9-7	12-2	14-10	17-3	
	Hem-Fir	#3	5-7	8-3	10-5	12-9	14-9	5-0	7-4	9-4	11-5	13-2	
	Southern Pine	SS	7-8	12-0	15-10	20-2	24-7	7-8	12-0	15-10	20-2	24-7	
	Southern Pine	#1	7-6	11-9	15-6	19-7	23-4	7-6	11-9	14-9	17-6	20-11	
	Southern Pine	#2	7-4	11-5	14-9	17-7	20-7	7-1	10-2	13-2	15-9	18-5	
	Southern Pine	#3	6-0	8-10	11-3	13-4	15-10	5-4	7-11	10-1	11-11	14-2	
	Spruce-Pine-Fir	SS	7-2	11-4	14-11	19-0	23-1	7-2	11-4	14-9	18-0	20-11	
	Spruce-Pine-Fir	#1	7-0	10-11	13-9	16-10	19-6	6-8	9-9	12-4	15-1	17-6	
	Spruce-Pine-Fir	#2	7-0	10-11	13-9	16-10	19-6	6-8	9-9	12-4	15-1	17-6	
	Spruce-Pine-Fir	#3	5-7	8-3	10-5	12-9	14-9	5-0	7-4	9-4	11-5	13-2	
	24	Douglas Fir-Larch	SS	7-3	11-4	15-0	19-1	22-6	7-3	11-3	14-2	17-4	20-1
		Douglas Fir-Larch	#1	7-0	10-5	13-2	16-1	18-8	6-4	9-4	11-9	14-5	16-8
		Douglas Fir-Larch	#2	6-8	9-9	12-4	15-1	17-6	5-11	8-8	11-0	13-6	15-7
Douglas Fir-Larch		#3	5-0	7-4	9-4	11-5	13-2	4-6	6-7	8-4	10-2	11-10	
Hem-Fir		SS	6-10	10-9	14-2	18-0	21-11	6-10	10-9	13-11	17-0	19-9	
Hem-Fir		#1	6-8	10-2	12-10	15-8	18-2	6-2	9-1	11-6	14-0	16-3	
Hem-Fir		#2	6-4	9-7	12-2	14-10	17-3	5-10	8-7	10-10	13-3	15-5	
Hem-Fir		#3	5-0	7-4	9-4	11-5	13-2	4-6	6-7	8-4	10-2	11-10	
Southern Pine		SS	7-1	11-2	14-8	18-9	22-10	7-1	11-2	14-8	18-9	22-10	
Southern Pine		#1	7-0	10-11	14-5	17-6	20-11	7-0	10-6	13-2	15-8	18-8	
Southern Pine		#2	6-10	10-2	13-2	15-9	18-5	6-4	9-2	11-9	14-1	16-6	
Southern Pine		#3	5-4	7-11	10-1	11-11	14-2	4-9	7-1	9-0	10-8	12-8	
Spruce-Pine-Fir		SS	6-8	10-6	13-10	17-8	20-11	6-8	10-5	13-2	16-1	18-8	
Spruce-Pine-Fir		#1	6-6	9-9	12-4	15-1	17-6	5-11	8-8	11-0	13-6	15-7	
Spruce-Pine-Fir		#2	6-6	9-9	12-4	15-1	17-6	5-11	8-8	11-0	13-6	15-7	
Spruce-Pine-Fir		#3	5-0	7-4	9-4	11-5	13-2	4-6	6-7	8-4	10-2	11-10	

For SI: 1 inch = 25.4 mm, 1 foot = 304.8 mm, 1 pound per square foot = 47.9 N/m².
 a. Span exceeds 26 feet in length. Check sources for availability of lumber in lengths greater than 20 feet.

TABLE 2308.10.3(6)
RAFTER SPANS FOR COMMON LUMBER SPECIES
 (Ground Snow Load = 50 pounds per square foot, Ceiling Attached to Rafters, $L/\Delta = 240$)

RAFTER SPACING (inches)	SPECIES AND GRADE	DEAD LOAD = 10 pounds per square foot						DEAD LOAD = 20 pounds per square foot					
		2 x 4	2 x 6	2 x 8	2 x 10	2 x 12	2 x 4	2 x 6	2 x 8	2 x 10	2 x 12		
		(ft. - in.)	(ft. - in.)	(ft. - in.)	(ft. - in.)	(ft. - in.)	(ft. - in.)	(ft. - in.)	(ft. - in.)	(ft. - in.)	(ft. - in.)		
12	Douglas Fir-Larch	SS	7-8	12-1	15-11	20-3	24-8	7-8	12-1	15-11	20-3	24-0	
	Douglas Fir-Larch	#1	7-5	11-7	15-3	18-7	21-7	7-5	11-2	14-1	17-3	20-0	
	Douglas Fir-Larch	#2	7-3	11-3	14-3	17-5	20-2	7-1	10-5	13-2	16-1	18-8	
	Douglas Fir-Larch	#3	5-10	8-6	10-9	13-2	15-3	5-5	7-10	10-0	12-2	14-1	
	Hem-Fir	SS	7-3	11-5	15-0	19-2	23-4	7-3	11-5	15-0	19-2	23-4	
	Hem-Fir	#1	7-1	11-2	14-8	18-1	21-0	7-1	10-10	13-9	16-9	19-5	
	Hem-Fir	#2	6-9	10-8	14-0	17-2	19-11	6-9	10-3	13-0	15-10	18-5	
	Hem-Fir	#3	5-10	8-6	10-9	13-2	15-3	5-5	7-10	10-0	12-2	14-1	
	Southern Pine	SS	7-6	11-0	15-7	19-11	24-3	7-6	11-10	15-7	19-11	24-3	
	Southern Pine	#1	7-5	11-7	15-4	19-7	23-9	7-5	11-7	15-4	18-9	22-4	
	Southern Pine	#2	7-3	11-5	15-0	18-2	21-3	7-3	10-11	14-1	16-10	19-9	
	Southern Pine	#3	6-2	9-2	11-8	13-9	16-4	5-9	8-5	10-9	12-9	15-2	
16	Spruce-Pine-Fir	SS	7-1	11-2	14-8	18-9	22-10	7-1	11-2	14-8	18-9	22-4	
	Spruce-Pine-Fir	#1	6-11	10-11	14-3	17-5	20-2	6-11	10-5	13-2	16-1	18-8	
	Spruce-Pine-Fir	#2	6-11	10-11	14-3	17-5	20-2	6-11	10-5	13-2	16-1	18-8	
	Spruce-Pine-Fir	#3	5-10	8-6	10-9	13-2	15-3	5-5	7-10	10-0	12-2	14-1	
	Douglas Fir-Larch	SS	7-0	11-0	14-5	18-5	22-5	7-0	11-0	14-5	17-11	20-10	
	Douglas Fir-Larch	#1	6-9	10-5	13-2	16-1	18-8	6-7	9-8	12-2	14-11	17-3	
	Douglas Fir-Larch	#2	6-7	9-9	12-4	15-1	17-6	6-2	9-0	11-5	13-11	16-2	
	Douglas Fir-Larch	#3	5-0	7-4	9-4	11-5	13-2	4-8	6-10	8-8	10-6	12-3	
	Hem-Fir	SS	6-7	10-4	13-8	17-5	21-2	6-7	10-4	13-8	17-5	20-5	
	Hem-Fir	#1	6-5	10-2	12-10	15-8	18-2	6-5	9-5	11-11	14-6	16-10	
	Hem-Fir	#2	6-2	9-7	12-2	14-10	17-3	6-1	8-11	11-3	13-9	15-11	
	Hem-Fir	#3	5-0	7-4	9-4	11-5	13-2	4-8	6-10	8-8	10-6	12-3	
16	Southern Pine	SS	6-10	10-9	14-2	18-1	22-0	6-10	10-9	14-2	18-1	22-0	
	Southern Pine	#1	6-9	10-7	13-11	17-6	20-11	6-9	10-7	13-8	16-2	19-4	
	Southern Pine	#2	6-7	10-2	13-2	15-9	18-5	6-7	9-5	12-2	14-7	17-1	
	Southern Pine	#3	5-4	7-11	10-1	11-11	14-2	4-11	7-4	9-4	11-0	13-1	
	Spruce-Pine-Fir	SS	6-5	10-2	13-4	17-0	20-9	6-5	10-2	13-4	16-8	19-4	
	Spruce-Pine-Fir	#1	6-4	9-9	12-4	15-1	17-6	6-2	9-0	11-5	13-11	16-2	
	Spruce-Pine-Fir	#2	6-4	9-9	12-4	15-1	17-6	6-2	9-0	11-5	13-11	16-2	
	Spruce-Pine-Fir	#3	5-0	7-4	9-4	11-5	13-2	4-8	6-10	8-8	10-6	12-3	

(continued)

TABLE 2308.10.3(6)—continued
RAFTER SPANS FOR COMMON LUMBER SPECIES
 (Ground Snow Load = 50 pounds per square foot, Ceiling Attached to Rafters, L/Δ = 240)

RAFTER SPACING (inches)	DEAD LOAD = 10 pounds per square foot												DEAD LOAD = 20 pounds per square foot																											
	2 x 4				2 x 6				2 x 8				2 x 10				2 x 12				2 x 4				2 x 6				2 x 8				2 x 10				2 x 12			
	SPECIES AND GRADE		(ft. - in.)	(ft. - in.)	(ft. - in.)	(ft. - in.)	(ft. - in.)	(ft. - in.)	(ft. - in.)	(ft. - in.)	(ft. - in.)	(ft. - in.)	(ft. - in.)	(ft. - in.)	(ft. - in.)	(ft. - in.)	(ft. - in.)	(ft. - in.)	(ft. - in.)	(ft. - in.)	(ft. - in.)	(ft. - in.)	(ft. - in.)	(ft. - in.)	(ft. - in.)	(ft. - in.)	(ft. - in.)	(ft. - in.)	(ft. - in.)	(ft. - in.)	(ft. - in.)	(ft. - in.)	(ft. - in.)	(ft. - in.)	(ft. - in.)					
19.2	Douglas Fir-Larch	SS	6-7	10-4	13-7	17-4	20-6	6-7	10-4	13-5	16-5	19-0																												
	Douglas Fir-Larch	#1	6-4	9-6	12-0	14-8	17-1	6-0	8-10	11-2	13-7	15-9																												
	Douglas Fir-Larch	#2	6-1	8-11	11-3	13-9	15-11	5-7	8-3	10-5	12-9	14-9																												
	Douglas Fir-Larch	#3	4-7	6-9	8-6	10-5	12-1	4-3	6-3	7-11	9-7	11-2																												
	Hem-Fir	SS	6-2	9-9	12-10	16-5	19-11	6-2	9-9	12-10	16-1	18-8																												
	Hem-Fir	#1	6-1	9-3	11-9	14-4	16-7	5-10	8-7	10-10	13-3	15-5																												
	Hem-Fir	#2	5-9	8-9	11-1	13-7	15-9	5-7	8-1	10-3	12-7	14-7																												
	Hem-Fir	#3	4-7	6-9	8-6	10-5	12-1	4-3	6-3	7-11	9-7	11-2																												
	Southern Pine	SS	6-5	10-2	13-4	17-0	20-9	6-5	10-2	13-4	17-0	20-9																												
	Southern Pine	#1	6-4	9-11	13-1	16-0	19-1	6-4	9-11	12-5	14-10	17-8																												
	Southern Pine	#2	6-2	9-4	12-0	14-4	16-10	6-0	8-8	11-2	13-4	15-7																												
	Southern Pine	#3	4-11	7-3	9-2	10-10	12-11	4-6	6-8	8-6	10-1	12-0																												
	Spruce-Pine-Fir	SS	6-1	9-6	12-7	16-0	19-1	6-1	9-6	12-5	15-3	17-8																												
	Spruce-Pine-Fir	#1	5-11	8-11	11-3	13-9	15-11	5-7	8-3	10-5	12-9	14-9																												
	Spruce-Pine-Fir	#2	5-11	8-11	11-3	13-9	15-11	5-7	8-3	10-5	12-9	14-9																												
	Spruce-Pine-Fir	#3	4-7	6-9	8-6	10-5	12-1	4-3	6-3	7-11	9-7	11-2																												
	24	Douglas Fir-Larch	SS	6-1	9-7	12-7	15-10	18-4	6-1	9-6	12-0	14-8																												
		Douglas Fir-Larch	#1	5-10	8-6	10-9	13-2	15-3	5-5	7-10	10-0	12-2	14-1																											
Douglas Fir-Larch		#2	5-5	7-11	10-1	12-4	14-3	5-0	7-4	9-4	11-5	13-2																												
Douglas Fir-Larch		#3	4-1	6-0	7-7	9-4	10-9	3-10	5-7	7-1	8-7	10-0																												
Hem-Fir		SS	5-9	9-1	11-11	15-12	18-0	5-9	9-1	11-9	14-5	16-8																												
Hem-Fir		#1	5-8	8-3	10-6	12-10	14-10	5-3	7-8	9-9	11-10	13-9																												
Hem-Fir		#2	5-4	7-10	9-11	12-1	14-1	4-11	7-3	9-2	11-3	13-0																												
Hem-Fir		#3	4-1	6-0	7-7	9-4	10-9	3-10	5-7	7-1	8-7	10-0																												
Southern Pine		SS	6-0	9-5	12-5	15-10	19-3	6-0	9-5	12-5	15-10	19-3																												
Southern Pine		#1	5-10	9-3	12-0	14-4	17-1	5-10	8-10	11-2	13-3	15-9																												
Southern Pine		#2	5-9	8-4	10-9	12-10	15-1	5-5	7-9	10-0	11-11	13-11																												
Southern Pine		#3	4-4	6-5	8-3	9-9	11-7	4-1	6-0	7-7	9-0	10-8																												
Spruce-Pine-Fir		SS	5-8	8-10	11-8	14-8	17-1	5-8	8-10	11-2	13-7	15-9																												
Spruce-Pine-Fir		#1	5-5	7-11	10-1	12-4	14-3	5-0	7-4	9-4	11-5	13-2																												
Spruce-Pine-Fir		#2	5-5	7-11	10-1	12-4	14-3	5-0	7-4	9-4	11-5	13-2																												
Spruce-Pine-Fir		#3	4-1	6-0	7-7	9-4	10-9	3-10	5-7	7-1	8-7	10-0																												

For SI: 1 inch = 25.4 mm, 1 foot = 304.8 mm, 1 pound per square foot = 47.9 N/m².

**TABLE 2308.10.4.1
RAFTER TIE CONNECTIONS^g**

RAFTER SLOPE	TIE SPACING (inches)	GROUND SNOW LOAD (pound per square foot)											
		NO SNOW LOAD				30 pounds per square foot				50 pounds per square foot			
		Roof span (feet)											
		12	20	28	36	12	20	28	36	12	20	28	36
Required number of 16d common (3 1/2" x 0.162") nails ^{a,b} per connection ^{c,d,e,f}													
3:12	12	4	6	8	10	4	6	8	11	5	8	12	15
	16	5	7	10	13	5	8	11	14	6	11	15	20
	24	7	11	15	19	7	11	16	21	9	16	23	30
	32	10	14	19	25	10	16	22	28	12	27	30	40
	48	14	21	29	37	14	32	36	42	18	32	46	60
4:12	12	3	4	5	6	3	5	6	8	4	6	9	11
	16	3	5	7	8	4	6	8	11	5	8	12	15
	24	4	7	10	12	5	9	12	16	7	12	17	22
	32	6	9	13	16	8	12	16	22	10	16	24	30
	48	8	14	19	24	10	18	24	32	14	24	34	44
5:12	12	3	3	4	5	3	4	5	7	3	5	7	9
	16	3	4	5	7	3	5	7	9	4	7	9	12
	24	4	6	8	10	4	7	10	13	6	10	14	18
	32	5	8	10	13	6	10	14	18	8	14	18	24
	48	7	11	15	20	8	14	20	26	12	20	28	36
7:12	12	3	3	3	4	3	3	4	5	3	4	5	7
	16	3	3	4	5	3	4	5	6	3	5	7	9
	24	3	4	6	7	3	5	7	9	4	7	10	13
	32	4	6	8	10	4	8	10	12	6	10	14	18
	48	5	8	11	14	6	10	14	18	9	14	20	26
9:12	12	3	3	3	3	3	3	3	4	3	3	4	5
	16	3	3	3	4	3	3	4	5	3	4	5	7
	24	3	3	5	6	3	4	6	7	3	6	8	10
	32	3	4	6	8	4	6	8	10	5	8	10	14
	48	4	6	9	11	5	8	12	14	7	12	16	20
12:12	12	3	3	3	3	3	3	3	3	3	3	3	4
	16	3	3	3	3	3	3	3	4	3	3	4	5
	24	3	3	3	4	3	3	4	6	3	4	6	8
	32	3	3	4	5	3	5	6	8	4	6	8	10
	48	3	4	6	7	4	7	8	12	6	8	12	16

For SI: 1 inch = 25.4 mm, 1 foot = 304.8 mm, 1 pound per square foot = 47.8 N/m².

a. 40d box (5" x 0.162") or 16d sinker (3 1/4" x 0.148") nails are permitted to be substituted for 16d common (3 1/2" x 0.16") nails.

b. Nailing requirements are permitted to be reduced 25 percent if nails are clinched.

c. Rafter tie heel joint connections are not required where the ridge is supported by a load-bearing wall, header or ridge beam.

d. When intermediate support of the rafter is provided by vertical struts or purlins to a load-bearing wall, the tabulated heel joint connection requirements are permitted to be reduced proportionally to the reduction in span.

e. Equivalent nailing patterns are required for ceiling joist to ceiling joist lap splices.

f. Connected members shall be of sufficient size to prevent splitting due to nailing.

g. For snow loads less than 30 pounds per square foot, the required number of nails is permitted to be reduced by multiplying by the ratio of actual snow load plus 10 divided by 40, but not less than the number required for no snow load.

**TABLE 2308.10.9
ALLOWABLE SPANS FOR 2-INCH TONGUE-AND-GROOVE DECKING**

SPAN ^a (feet)	LIVE LOAD (pound per square foot)	DEFLECTION LIMIT	BENDING STRESS (f) (pound per square inch)	MODULUS OF ELASTICITY (E) (pound per square inch)
Roofs				
4	20	1/240 1/360	160	170,000 256,000
	30	1/240 1/360	210	256,000 384,000
	40	1/240 1/360	270	340,000 512,000
4.5	20	1/240 1/360	200	242,000 305,000
	30	1/240 1/360	270	363,000 405,000
	40	1/240 1/360	350	484,000 725,000
5.0	20	1/240 1/360	250	332,000 500,000
	30	1/240 1/360	330	495,000 742,000
	40	1/240 1/360	420	660,000 1,000,000
5.5	20	1/240 1/360	300	442,000 660,000
	30	1/240 1/360	400	662,000 998,000
	40	1/240 1/360	500	884,000 1,330,000
6.0	20	1/240 1/360	360	575,000 862,000
	30	1/240 1/360	480	862,000 1,295,000
	40	1/240 1/360	600	1,150,000 1,730,000
6.5	20	1/240 1/360	420	595,000 892,000
	30	1/240 1/360	560	892,000 1,340,000
	40	1/240 1/360	700	1,190,000 1,730,000
7.0	20	1/240 1/360	490	910,000 1,360,000
	30	1/240 1/360	650	1,370,000 2,000,000
	40	1/240 1/360	810	1,820,000 2,725,000

(continued)

TABLE 2308.10.9—continued
ALLOWABLE SPANS FOR 2-INCH TONGUE-AND-GROOVE DECKING

SPAN ^a (feet)	LIVE LOAD (pound per square foot)	DEFLECTION LIMIT	BENDING STRESS (f) (pound per square inch)	MODULUS OF ELASTICITY (E) (pound per square inch)
Roofs				
7.5	20	1/240	560	1,125,000
		1/360		1,685,000
	30	1/240	750	1,685,000
	40	1/360	930	2,250,000
8.0	20	1/240	640	1,360,000
		1/360		2,040,000
	30	1/240	850	2,040,000
		1/360		3,060,000
Floors				
4	40	1/360	840	1,000,000
4.5			950	1,300,000
5.0			1,060	1,600,000

For SI: 1 inch = 25.4 mm, 1 foot = 304.8 mm, 1 pound per square foot = 0.0479 kN/m², 1 pound per square inch = 0.00689 N/mm².

a. Spans are based on simple beam action with 10 pounds per square foot dead load and provisions for a 300-pound concentrated load on a 12-inch width of decking. Random layout is permitted in accordance with the provisions of Section 2308.10.9. Lumber thickness is 1½ inches nominal.

2308.10.4.2 Notches and holes. Notching at the ends of rafters or ceiling joists shall not exceed one-fourth the depth. Notches in the top or bottom of the rafter or ceiling joist shall not exceed one-sixth the depth and shall not be located in the middle one-third of the span, except that a notch not exceeding one-third of the depth is permitted in the top of the rafter or ceiling joist not further from the face of the support than the depth of the member.

Holes bored in rafters or ceiling joists shall not be within 2 inches (51 mm) of the top and bottom and their diameter shall not exceed one-third the depth of the member.

2308.10.4.3 Framing around openings. Trimmer and header rafters shall be doubled, or of lumber of equivalent cross section, where the span of the header exceeds 4 feet (1219 mm). The ends of header rafters more than 6 feet (1829 mm) long shall be supported by framing anchors or rafter hangers unless bearing on a beam, partition or wall.

2308.10.5 Purlins. Purlins to support roof loads are permitted to be installed to reduce the span of rafters within allowable limits and shall be supported by struts to bearing walls. The maximum span of 2-inch by 4-inch (51 mm by 102 mm) purlins shall be 4 feet (1219 mm). The maximum span of the 2-inch by 6-inch (51 mm by 152 mm) purlin shall be 6 feet (1829 mm), but in no case shall the purlin be smaller than the supported rafter. Struts shall not be smaller than 2-inch by 4-inch (51 mm by 102 mm) members. The unbraced length of struts shall not exceed 8 feet (2438 mm) and the minimum slope of the struts shall not be less than 45 degrees (0.79 rad) from the horizontal.

2308.10.6 Blocking. Roof rafters and ceiling joists shall be supported laterally to prevent rotation and lateral displacement in accordance with the provisions of Section 2308.8.5.

2308.10.7 Engineered wood products. Prefabricated wood I-joists, structural glued-laminated timber and structural composite lumber shall not be notched or drilled except where permitted by the manufacturer's recommendations or where the effects of such alterations are specifically considered in the design of the member by a registered design professional.

2308.10.8 Roof sheathing. Roof sheathing shall be in accordance with Tables 2304.7(3) and 2304.7(5) for wood structural panels, and Tables 2304.7(1) and 2304.7(2) for lumber and shall comply with Section 2304.7.2.

2308.10.8.1 Joints. Joints in lumber sheathing shall occur over supports unless approved end-matched lumber is used, in which case each piece shall bear on at least two supports.

2308.10.9 Roof planking. Planking shall be designed in accordance with the general provisions of this code.

In lieu of such design, 2-inch (51 mm) tongue-and-groove planking is permitted in accordance with Table 2308.10.9. Joints in such planking are permitted to be randomly spaced, provided the system is applied to not less than three continuous spans, planks are center matched and end matched or splined, each plank bears on at least one support, and joints are separated by at least 24 inches (610 mm) in adjacent pieces.

2308.10.10 Wood trusses. Wood trusses shall be designed in accordance with Section 2303.4.

2308.10.11 Attic ventilation. For attic ventilation, see Section 1203.2.

2308.11 Additional requirements for conventional construction in Seismic Design Category B or C. Structures of conventional light-frame construction in Seismic Design Category B or C, as determined in Section 1613, shall comply with Sections 2308.11.1 through 2308.11.3, in addition to the provisions of Sections 2308.1 through 2308.10.

2308.11.1 Number of stories. Structures of conventional light-frame construction shall not exceed two stories in height in Seismic Design Category C.

2308.11.2 Concrete or masonry. Concrete or masonry walls or masonry veneer shall not extend above the basement.

Exceptions:

1. Masonry veneer is permitted to be used in the first two stories above grade plane or the first three stories above grade plane where the lowest story has concrete or masonry walls in Seismic Design Category B, provided that structural use panel wall bracing is used and the length of bracing provided is one- and one-half times the required length as determined in Table 2308.9.3(1).
2. Masonry veneer is permitted to be used in the first story above grade plane or the first two stories above grade plane where the lowest story has concrete or masonry walls in Seismic Design Category B or C.
3. Masonry veneer is permitted to be used in the first two stories above grade plane in Seismic Design Category B or C, provided the following criteria are met:

egories B and C, provided the following criteria are met:

- 3.1. Type of brace per Section 2308.9.3 shall be Method 3 and the allowable shear capacity in accordance with Table 2306.4.1 shall be a minimum of 350 plf (5108 N/m).
- 3.2. The bracing of the top story shall be located at each end and at least every 25 feet (7620 mm) o.c. but not less than 40 percent of the braced wall line. The bracing of the first story shall be located at each end and at least every 25 feet (7620 mm) o.c. but not less than 35 percent of the braced wall line.
- 3.3. Hold-down connectors shall be provided at the ends of braced walls for the second floor to first floor wall assembly with an allowable design of 2,000 pounds (8896 N). Hold-down connectors shall be provided at the ends of each wall segment of the braced walls for the first floor to foundation with an allowable design of 3,900 pounds (17 347 N). In all cases, the hold-down connector force shall be transferred to the foundation.
- 3.4. Cripple walls shall not be permitted.

2308.11.3 Framing and connection details. Framing and connection details shall conform to Sections 2308.11.3.1 through 2308.11.3.3.

2308.11.3.1 Anchorage. Braced wall lines shall be anchored in accordance with Section 2308.6 at foundations.

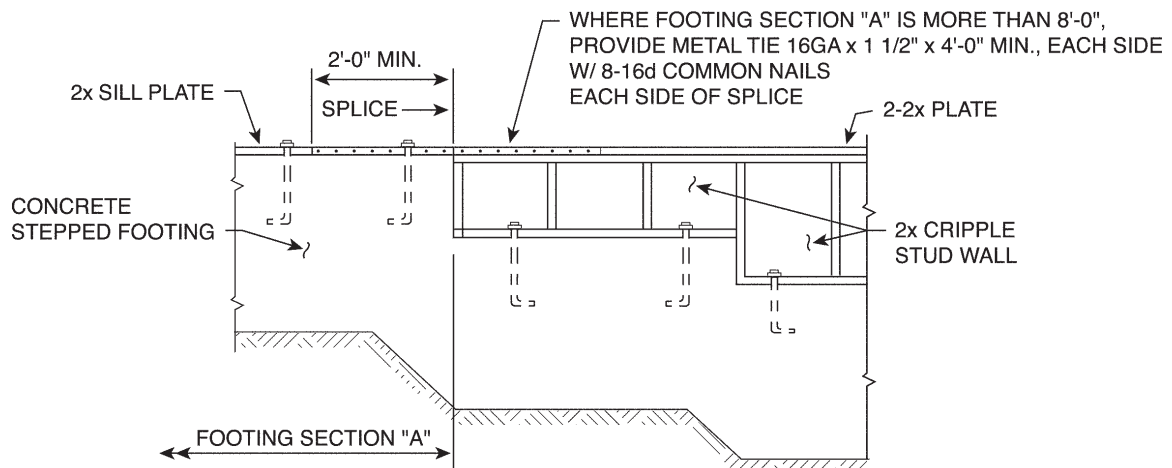

NOTE: WHERE FOOTING SECTION "A" IS LESS THAN 8'-0" LONG IN A 25'-0" TOTAL LENGTH WALL, PROVIDE BRACING AT CRIPPLE STUD WALL

For SI: 1 inch = 25.4 mm, 1 foot = 304.8 mm.

FIGURE 2308.11.3.2
STEPPED FOOTING CONNECTION DETAILS

2308.11.3.2 Stepped footings. Where the height of a required braced wall panel extending from foundation to floor above varies more than 4 feet (1219 mm), the following construction shall be used:

1. Where the bottom of the footing is stepped and the lowest floor framing rests directly on a sill bolted to the footings, the sill shall be anchored as required in Section 2308.3.3.
2. Where the lowest floor framing rests directly on a sill bolted to a footing not less than 8 feet (2438 mm) in length along a line of bracing, the line shall be considered to be braced. The double plate of the cripple stud wall beyond the segment of footing extending to the lowest framed floor shall be spliced to the sill plate with metal ties, one on each side of the sill and plate. The metal ties shall not be less than 0.058 inch [1.47 mm (16 galvanized gauge)] by 1.5 inches (38 mm) wide by 48 inches (1219 mm) with eight 16d common nails on each side of the splice location (see Figure 2308.11.3.2). The metal tie shall have a minimum yield of 33,000 pounds per square inch (psi) (227 MPa).
3. Where cripple walls occur between the top of the footing and the lowest floor framing, the bracing requirements for a story shall apply.

2308.11.3.3 Openings in horizontal diaphragms. Openings in horizontal diaphragms with a dimension perpendicular to the joist that is greater than 4 feet (1.2 m) shall be constructed in accordance with the following:

1. Blocking shall be provided beyond headers.
2. Metal ties not less than 0.058 inch [1.47 mm (16 galvanized gauge)] by 1.5 inches (38 mm) wide

with eight 16d common nails on each side of the header-joist intersection shall be provided (see Figure 2308.11.3.3). The metal ties shall have a minimum yield of 33,000 psi (227 MPa).

2308.12 Additional requirements for conventional construction in Seismic Design Category D or E. Structures of conventional light-frame construction in Seismic Design Category D or E, as determined in Section 1613, shall conform to Sections 2308.12.1 through 2308.12.9, in addition to the requirements for Seismic Design Category B or C in Section 2308.11.

2308.12.1 Number of stories. Structures of conventional light-frame construction shall not exceed one story in height in Seismic Design Category D or E.

2308.12.2 Concrete or masonry. Concrete or masonry walls or masonry veneer shall not extend above the basement.

Exception: Masonry veneer is permitted to be used in the first story above grade plane in Seismic Design Category D, provided the following criteria are met:

1. Type of brace in accordance with Section 2308.9.3 shall be Method 3 and the allowable shear capacity in accordance with Table 2306.4.1 shall be a minimum of 350 plf (5108 N/m).
2. The bracing of the first story shall be located at each end and at least every 25 feet (7620 mm) o.c. but not less than 45 percent of the braced wall line.
3. Hold-down connectors shall be provided at the ends of braced walls for the first floor to foundation with an allowable design of 2,100 pounds (9341 N).
4. Cripple walls shall not be permitted.

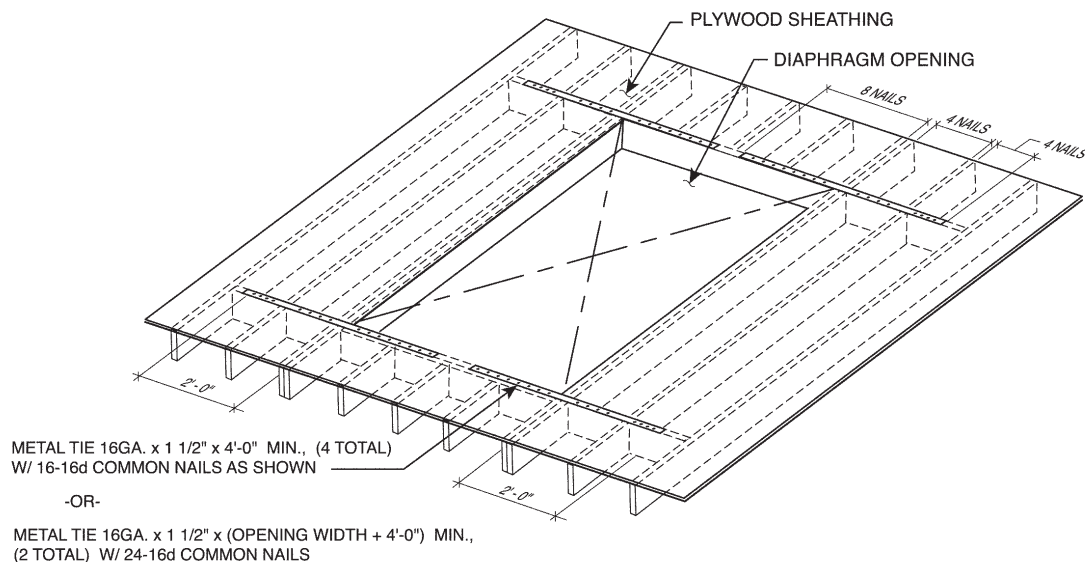

For SI: 1 inch = 25.4 mm, 1 foot = 304.8 mm.

FIGURE 2308.11.3.3
OPENINGS IN HORIZONTAL DIAPHRAGMS

2308.12.3 Braced wall line spacing. Spacing between interior and exterior braced wall lines shall not exceed 25 feet (7620 mm).

2308.12.4 Braced wall line sheathing. Braced wall lines shall be braced by one of the types of sheathing prescribed by Table 2308.12.4 as shown in Figure 2308.9.3. The sum of lengths of braced wall panels at each braced wall line shall conform to Table 2308.12.4. Braced wall panels shall be distributed along the length of the braced wall line and start at not more than 8 feet (2438 mm) from each end of the braced wall line. Panel sheathing joints shall occur over studs or blocking. Sheathing shall be fastened to studs, top and bottom plates and at panel edges occurring over blocking. Wall framing to which sheathing used for bracing is applied shall be nominal 2 inch wide [actual 1½ inch (38 mm)] or larger members.

Cripple walls having a stud height exceeding 14 inches (356 mm) shall be considered a story for the purpose of this section and shall be braced as required for braced wall lines in accordance with Table 2308.12.4. Where interior braced wall lines occur without a continuous foundation below, the length of parallel exterior cripple wall bracing shall be one and one-half times the lengths required by Table 2308.12.4. Where the cripple wall sheathing type used is Type S-W and this additional length of bracing cannot be provided, the capacity of Type S-W sheathing shall be increased by reducing the spacing of fasteners along the perimeter of each piece of sheathing to 4 inches (102 mm) o.c.

2308.12.5 Attachment of sheathing. Fastening of braced wall panel sheathing shall not be less than that prescribed in Table 2308.12.4 or 2304.9.1. Wall sheathing shall not be attached to framing members by adhesives.

2308.12.6 Irregular structures. Conventional light-frame construction shall not be used in irregular portions of structures in Seismic Design Category D or E. Such irregular portions of structures shall be designed to resist the forces specified in Chapter 16 to the extent such irregular features affect the performance of the conventional framing system. A portion of a structure shall be considered to be irregular

where one or more of the conditions described in Items 1 through 6 below are present.

1. Where exterior braced wall panels are not in one plane vertically from the foundation to the uppermost story in which they are required, the structure shall be considered to be irregular [see Figure 2308.12.6(1)].

Exception: Floors with cantilevers or setbacks not exceeding four times the nominal depth of the floor joists [see Figure 2308.12.6(2)] are permitted to support braced wall panels provided:

1. Floor joists are 2 inches by 10 inches (51 mm by 254 mm) or larger and spaced not more than 16 inches (406 mm) o.c.
2. The ratio of the back span to the cantilever is at least 2:1.
3. Floor joists at ends of braced wall panels are doubled.
4. A continuous rim joist is connected to the ends of cantilevered joists. The rim joist is permitted to be spliced using a metal tie not less than 0.058 inch (1.47 mm) (16 galvanized gauge) and 1½ inches (38 mm) wide fastened with six 16d common nails on each side. The metal tie shall have a minimum yield of 33,000 psi (227 MPa).
5. Joists at setbacks or the end of cantilevered joists shall not carry gravity loads from more than a single story having uniform wall and roof loads, nor carry the reactions from headers having a span of 8 feet (2438 mm) or more.

2. Where a section of floor or roof is not laterally supported by braced wall lines on all edges, the structure shall be considered to be irregular [see Figure 2308.12.6(3)].

Exception: Portions of roofs or floors that do not support braced wall panels above are permitted to

**TABLE 2308.12.4
WALL BRACING IN SEISMIC DESIGN CATEGORIES D AND E
(Minimum Length of Wall Bracing per each 25 Linear Feet of Braced Wall Line^a)**

CONDITION	SHEATHING TYPE ^b	$S_{DS} < 0.50$	$0.50 \leq S_{DS} < 0.75$	$0.75 \leq S_{DS} \leq 1.00$	$S_{DS} > 1.00$
One story	G-P ^c	10 feet 8 inches	14 feet 8 inches	18 feet 8 inches	25 feet 0 inches
	S-W	5 feet 4 inches	8 feet 0 inches	9 feet 4 inches	12 feet 0 inches

For SI: 1 inch = 25.4 mm, 1 foot = 304.8 mm.

- a. Minimum length of panel bracing of one face of the wall for S-W sheathing or both faces of the wall for G-P sheathing; h/w ratio shall not exceed 2:1. For S-W panel bracing of the same material on two faces of the wall, the minimum length is permitted to be one-half the tabulated value but the h/w ratio shall not exceed 2:1 and design for uplift is required.
- b. G-P = gypsum board, fiberboard, particleboard, lath and plaster or gypsum sheathing boards; S-W = wood structural panels and diagonal wood sheathing.
- c. Nailing as specified below shall occur at all panel edges at studs, at top and bottom plates and, where occurring, at blocking:
 - For ½-inch gypsum board, 5d (0.113 inch diameter) cooler nails at 7 inches on center;
 - For 5/8-inch gypsum board, No. 11 gauge (0.120 inch diameter) at 7 inches on center;
 - For gypsum sheathing board, 1¾ inches long by 7/16-inch head, diamond point galvanized nails at 4 inches on center;
 - For gypsum lath, No. 13 gauge (0.092 inch) by 1½ inches long, 19/64-inch head, plasterboard at 5 inches on center;
 - For Portland cement plaster, No. 11 gauge (0.120 inch) by 1½ inches long, 7/16-inch head at 6 inches on center;
 - For fiberboard and particleboard, No. 11 gauge (0.120 inch) by 1½ inches long, 7/16-inch head, galvanized nails at 3 inches on center.

extend up to 6 feet (1829 mm) beyond a braced wall line [see Figure 2308.12.6(4)].

- Where the end of a required braced wall panel extends more than 1 foot (305 mm) over an opening in the wall below, the structure shall be considered to be irregular. This requirement is applicable to braced wall panels offset in plane and to braced wall panels offset out of plane as permitted by the exception to Item 1 above in this section [see Figure 2308.12.6(5)].

Exception: Braced wall panels are permitted to extend over an opening not more than 8 feet (2438 mm) in width where the header is a 4-inch by 12-inch (102 mm by 305 mm) or larger member.

- Where portions of a floor level are vertically offset such that the framing members on either side of the offset cannot be lapped or tied together in an approved manner, the structure shall be considered to be irregular [see Figure 2308.12.6(6)].

Exception: Framing supported directly by foundations need not be lapped or tied directly together.

- Where braced wall lines are not perpendicular to each other, the structure shall be considered to be irregular [see Figure 2308.12.6(7)].

- Where openings in floor and roof diaphragms having a maximum dimension greater than 50 percent of the distance between lines of bracing or an area greater than 25 percent of the area between orthogonal pairs of braced wall lines are present, the structure shall be considered to be irregular [see Figure 2308.12.6(8)].

2308.12.7 Anchorage of exterior means of egress components. Exterior egress balconies, exterior exit stairways and similar means of egress components shall be positively anchored to the primary structure at not over 8 feet (2438 mm) o.c. or shall be designed for lateral forces. Such attachment shall not be accomplished by use of toenails or nails subject to withdrawal.

2308.12.8 Steel plate washers. Steel plate washers shall be placed between the foundation sill plate and the nut. Such washers shall be a minimum of 0.229 inch by 3 inches by 3 inches (5.82 mm by 76 mm by 76 mm) in size. The hole in the plate washer is permitted to be diagonally slotted with a width of up to $\frac{3}{16}$ inch (4.76 mm) larger than the bolt diameter and a slot length not to exceed $1\frac{3}{4}$ inches (44 mm), provided a standard cut washer is placed between the plate washer and the nut.

2308.12.9 Anchorage in Seismic Design Category E. Steel bolts with a minimum nominal diameter of $\frac{5}{8}$ inch (15.9 mm) shall be used in Seismic Design Category E.

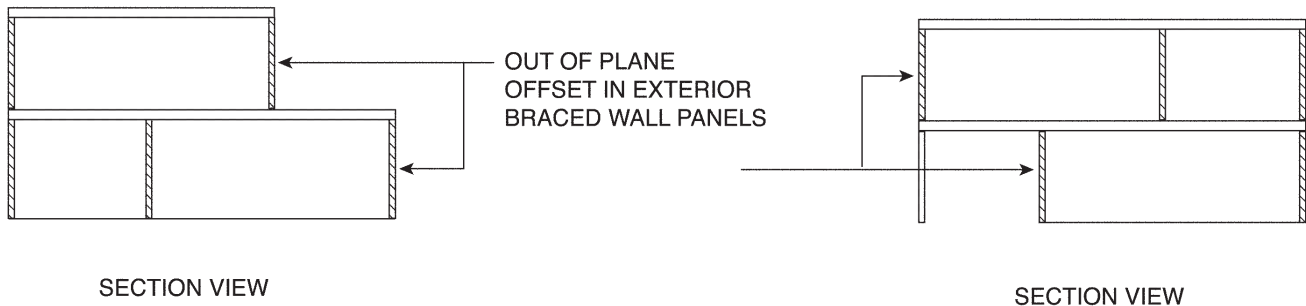

**FIGURE 2308.12.6(1)
BRACED WALL PANELS OUT OF PLANE**

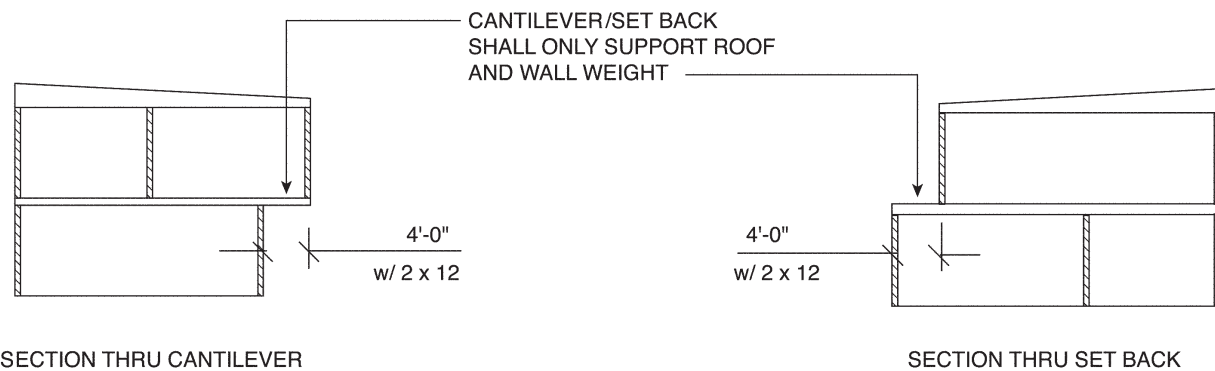

**FIGURE 2308.12.6(2)
BRACED WALL PANELS SUPPORTED BY CANTILEVER OR SET BACK**

For SI: 1 foot = 304.8 mm.

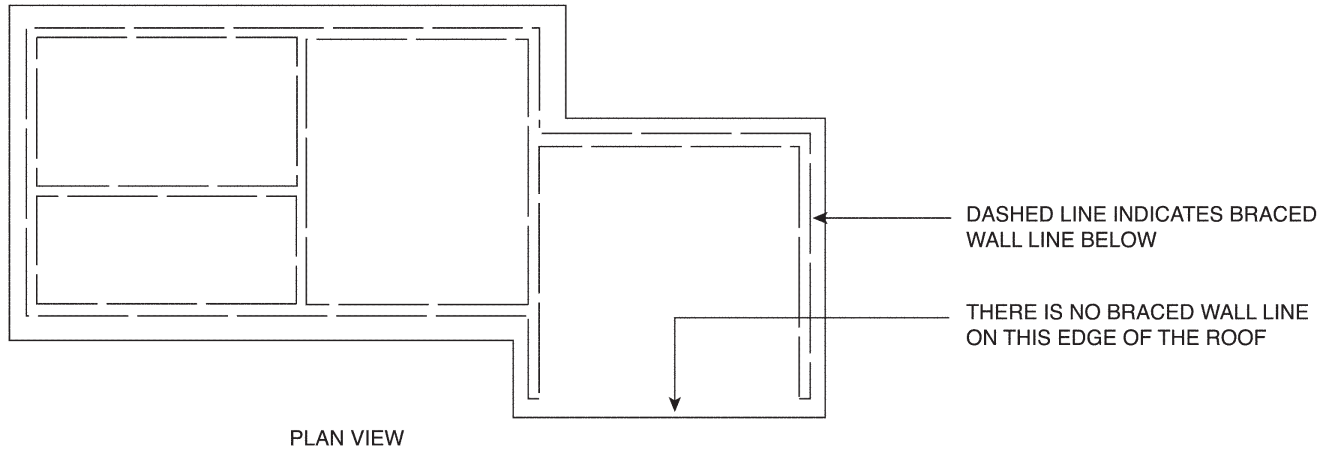
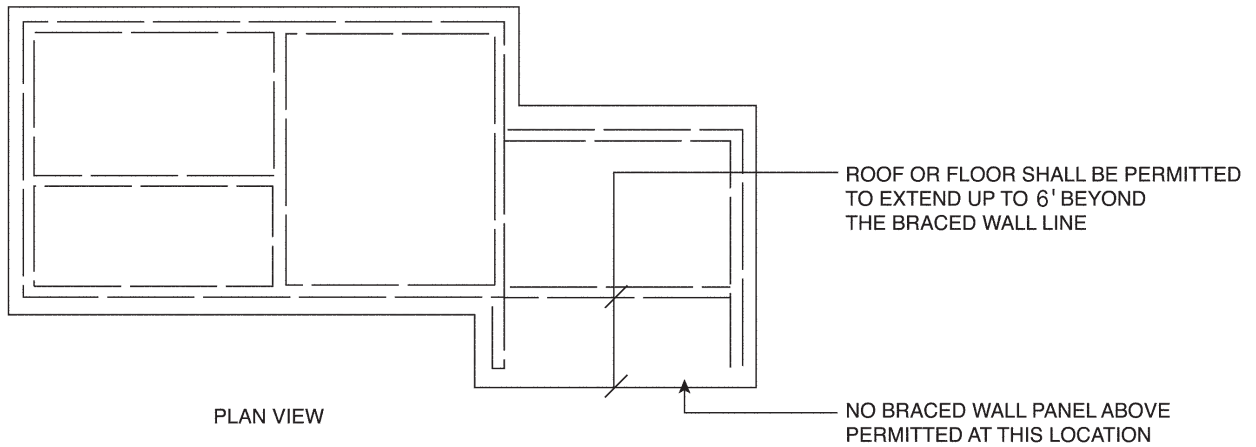
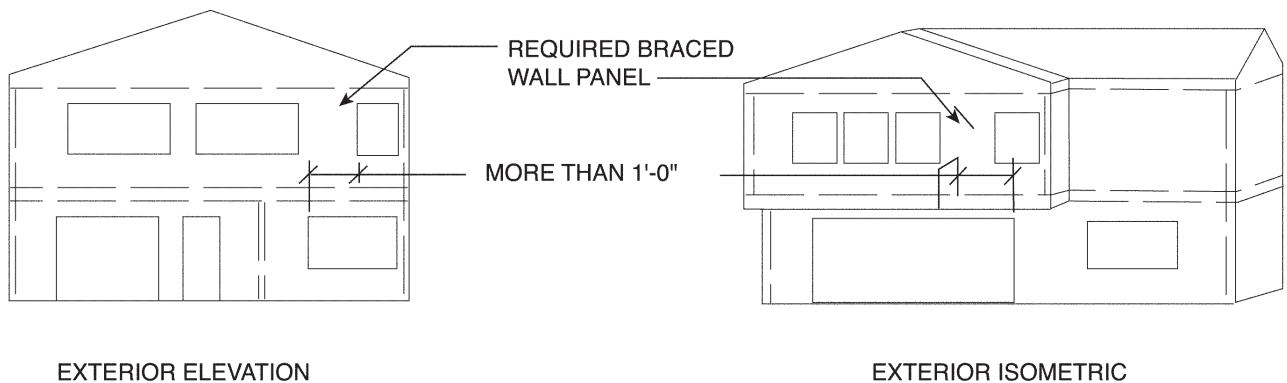

FIGURE 2308.12.6(3)
FLOOR OR ROOF NOT SUPPORTED ON ALL EDGES



For SI: 1 foot = 304.8 mm.

FIGURE 2308.12.6(4)
ROOF OR FLOOR EXTENSION BEYOND BRACED WALL LINE



For SI: 1 foot = 304.8 mm.

FIGURE 2308.12.6(5)
BRACED WALL PANEL EXTENSION OVER OPENING

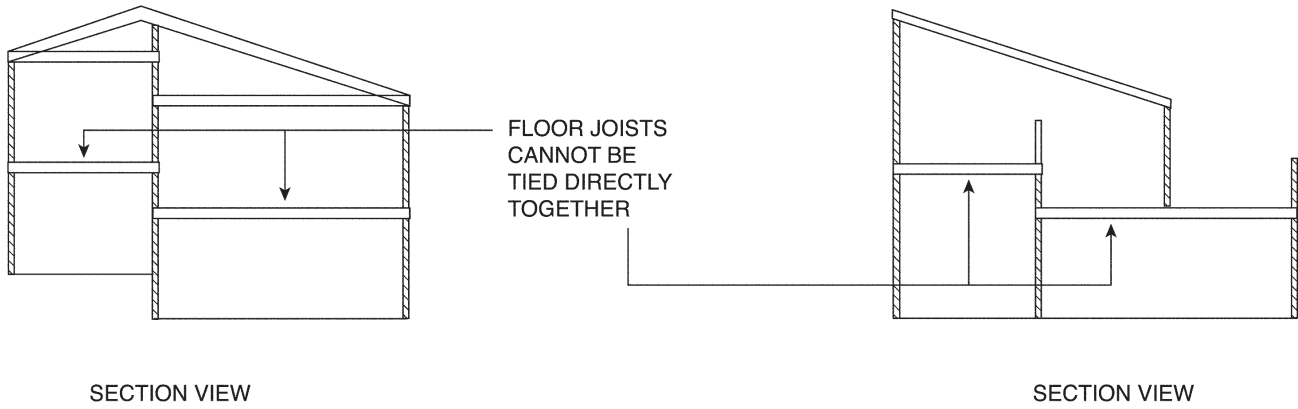

FIGURE 2308.12.6(6)
PORTIONS OF FLOOR LEVEL OFFSET VERTICALLY

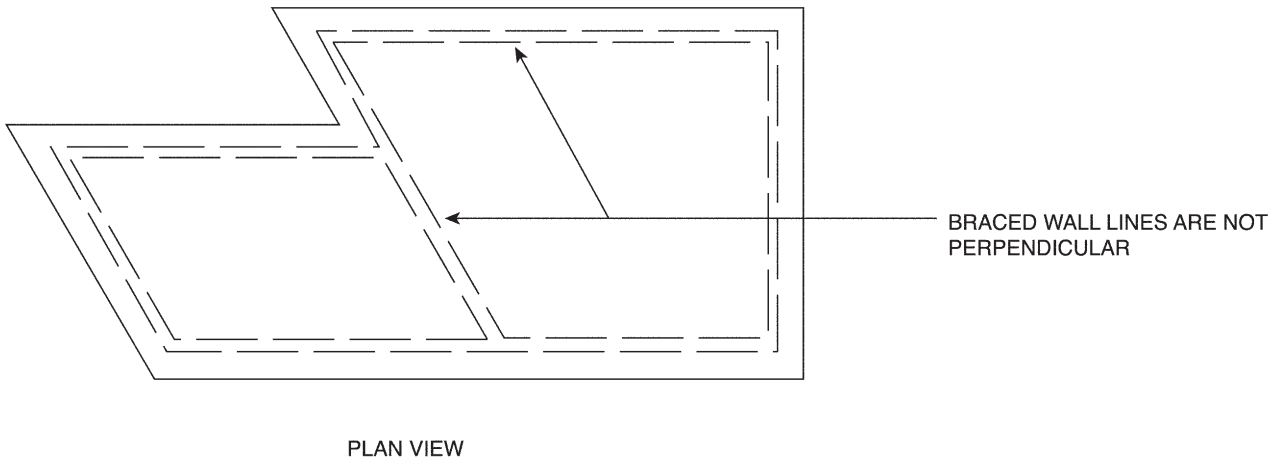

FIGURE 2308.12.6(7)
BRACED WALL LINES NOT PERPENDICULAR

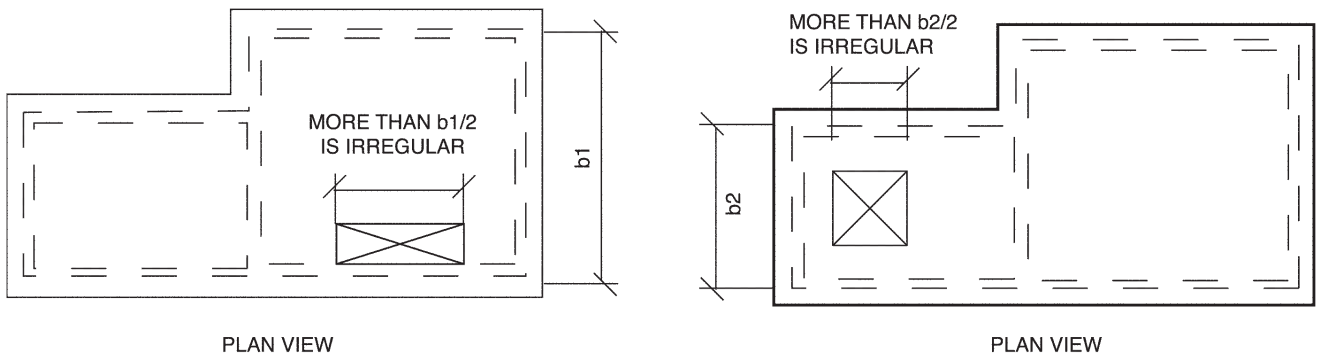

FIGURE 2308.12.6(8)
OPENING LIMITATIONS FOR FLOOR AND ROOF DIAPHRAGMS